

GS2000
(Part Number GR050)
Second Stage
—
SERVICE & REPAIR
GUIDE



Contents

INTRODUCTION	3
ABOUT THIS MANUAL	3
SCHEDULED SERVICE	3
EAN/ NITROX SERVICE	3
USE OF WARNINGS, CAUTIONS, & NOTES	3
FUNCTION & DESIGN	4
SECTION 1 – FACILITY REQUIREMENTS	5
TABLE 1 – RECOMMENDED EQUIPMENT AND SUPPLIERS	6
SECTION 2 – PRELIMINARY INSPECTION	7
EXTERNAL INSPECTION	7
IMMERSION / LEAK TEST	7
SECTION 3 – DISASSEMBLY PROCEDURES	8
GENERAL GUIDELINES	8
SECTION 4 – CLEANING PROCEDURES	15
ACIDIC CLEANING PROCEDURE	15
EAN/NITROX CLEANING PROCEDURE	18
SECTION 5 – REASSEMBLY PROCEDURES	25
GENERAL GUIDELINES	25
SECTION 6 – FINAL TESTING PROCEDURES	30
TABLE 2 – TROUBLESHOOTING GUIDE	34
SCHEMATIC & PARTS LIST	35

ABOUT THIS MANUAL

INTRODUCTION



As a service technician, you are entrusted with maintaining your customer's equipment to the same standards with which it was manufactured. At Genesis, we are committed to providing you with the tools you will need to accomplish this important task, including the information provided in this manual.

Possession of this manual, however, does not constitute an offer by Genesis Scuba to sell component parts, nor does it qualify you to perform service or repair for Genesis Scuba products. In order to purchase spare parts or perform service and repair, you must be directly employed by an Authorized Genesis Dealer. It is also your responsibility to obtain factory authorized training through your Genesis Scuba distributor.

If you are ever unsure about how to perform any of the procedures outlined in this manual, please contact Genesis Scuba for technical assistance.

SCHEDULED SERVICE

Regulators should be given the same care and maintenance as life support equipment. It is therefore important to perform scheduled overhaul service for the entire regulator (first and second stages) at least once every year with normal or infrequent use.

A unit that receives heavy or frequent use, however, should be serviced at least twice each year - or more often - depending on the conditions of use and the manner in which it is maintained. (Refer to the maintenance procedures outlined in the Genesis Regulator Owner's Manual.)

When performing service, whether it is a routine overhaul or a repair of a specific problem, it is important to understand how the regulator is designed and how it operates. An illustrated explanation of the GS2000 second stage design is provided on the following page.

EAN/ NITROX SERVICE

Genesis regulators can be upgraded for use with oxygen enriched air (EAN/ Nitrox) not to exceed 40% oxygen content. This upgrade must be performed in conjunction with a complete overhaul, and includes a special cleaning procedure that is outlined in this manual.

USE OF WARNINGS, CAUTIONS, & NOTES



WARNING indicates a procedure or situation that may result in serious injury or death if instructions are not followed correctly.



CAUTION indicates any situation or technique that will result in potential damage to the product, or render the product unsafe if instructions are not followed correctly.



NOTE is used to emphasize important points, tips, and reminders.

FUNCTION & DESIGN

INTRODUCTION

The GS2000 features a dynamically balanced valve with an independent adjustment mechanism. Here's how it works:

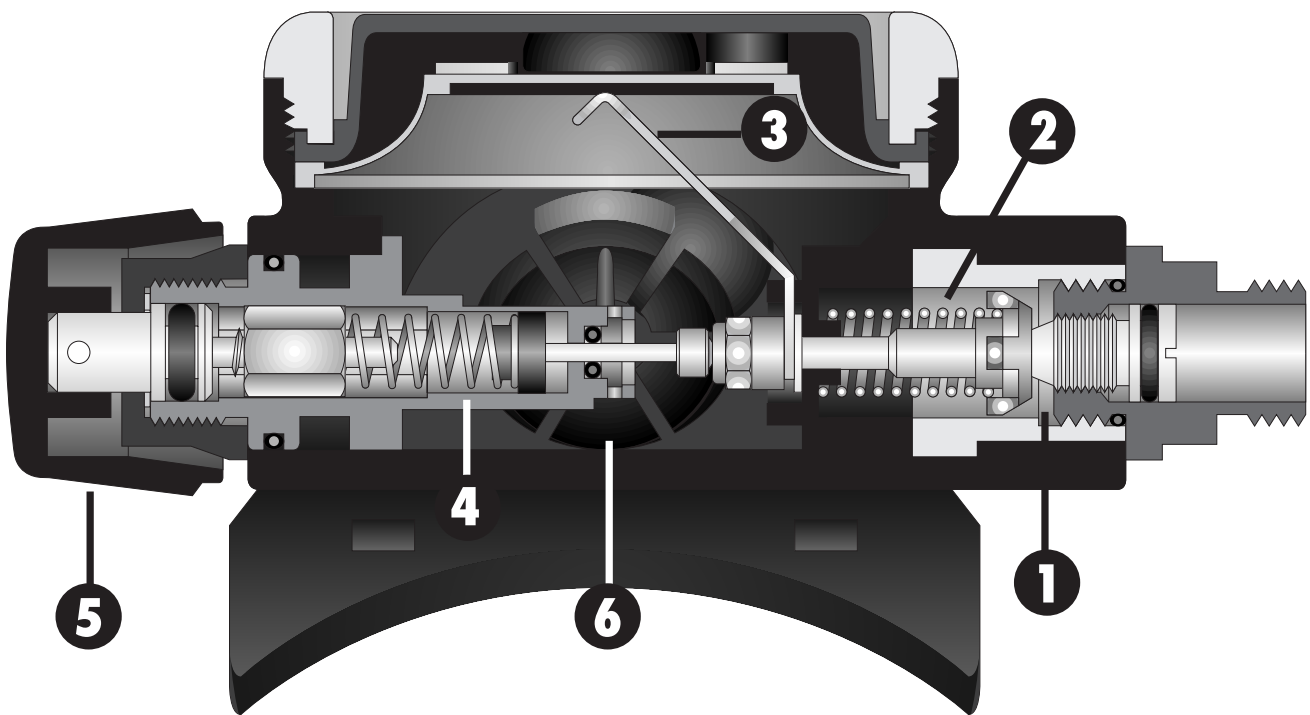

- ▼ Intermediate pressure air (140 psi) enters through the inlet coupling and orifice (1), where it meets the poppet and LP seat. The primary spring (2) holds the poppet against the orifice with a preset tension that is equal to or slightly less than the force of the intermediate pressure.
- ▼ Airflow is actuated when the diaphragm is drawn down over the lever (3). This pulls the poppet away from the orifice.
- ▼ Opening effort can be adjusted by turning the external adjustment knob (5), in order to increase or decrease the tension of the secondary spring (4). No wear or friction is exerted on the LP seat when the knob is turned. NOTE: A slightly positive airflow is created by turning the knob completely out to minimum resistance.
- ▼ The poppet is dynamically balanced between two spring tensions, in addition to pneumatic (ambient) pressure that fills the chamber surrounding the secondary spring. Ambient pressure increases upon descent, and decreases upon ascent to maintain a constant force against the poppet. The adjustment knob can be set once to maintain a consistent opening effort throughout the dive!
- ▼ Air and water are channeled to flow out through the exhaust valve (6), which is designed to minimize exhalation resistance while keeping the case internally dry in all positions.
- ▼ (Not shown) A dive/pre-dive switch can be set to minimize or boost peak venturi airflow, according to the diver's preference.

1

SECTION

FACILITY REQUIREMENTS

The service facility is perhaps the most important asset of any professional dive store. It should be clean and well lighted, and stocked with a complete inventory of parts and manufacturer's specialty tools for the products your store sells. As a minimum requirement, your service facility should be equipped with the following items:

- ❑ **Ultrasonic Cleaner** – Select the right size model that can keep up with the volume of regulators that your store services. A built in timer and heater will help control the cleaning time and temperature of the solution, since most solutions work best when heated.
- ❑ **Bench Mounted Vise** – A vise is sometimes needed to hold the regulator secure – especially when removing the first stage yoke retainer. Special care must be taken, however, to avoid damage that can result from improper use of this tool. Be sure to follow the instructions provided in this manual.
- ❑ **Magnification Lamp** – Strong lighting and magnification are essential requirements for performing a thorough parts inspection - especially when locating the cause of a small leak.
- ❑ **Quality Wrenches & Sockets** – When working with chrome plated brass parts, it is especially critical to use the correct size wrench and to ensure that it fits properly over the part. The use of an adjustable wrench is very likely to cause damage to your customer's regulator, and should be strictly avoided at all times.
- ❑ **Calibrated Inch-Pound Torque Wrench** – It is important to follow the manufacturer's torque values whenever they are specified, in order to avoid overtightening or under-tightening a part. This is especially important for smaller parts and fittings, when overtightening can easily damage the part.
- ❑ **Calibrated Foot-Pound Torque Wrench** – Torque wrenches that can be set for both inch-pound and foot-pound measurements generally tend to be less accurate than wrenches that are designed to measure torque within a specific range.
- ❑ **Manufacturer's Specialty Tools** – Specialty tools are critically important to performing each step of disassembly and reassembly according to each manufacturer's procedures. Genesis specialty tools that are required to perform service for the GS2000 second stage are pictured on the following page.

TABLE 1 – RECOMMENDED EQUIPMENT AND SUPPLIERS

The specialty tools shown below can be purchased directly from Genesis Scuba. For other items needed to outfit your store's service facility, we recommend the following suppliers:

Peter Built Co. www.scubatools.com	Manufacturer of custom designed specialty tools and test fixtures	Galion, OH 44833 Phone: 419-468-2212
Branson Ultrasonics www.bransoncleaning.com	Manufacturer of tabletop ultrasonic cleaners	Danbury, CT 06813 Phone: 203-796-2298
Lubrication Technology	Manufacturer of Christo-Lube 111 (Genesis approved lubricant)	Jackson, OH 45640 Phone: (740)286-2644
Lawrence Factor, Inc. www.lawrence-factor.com	Manufacturer of LFW™ (Lawrence Factor Wash) (Genesis approved acid bath cleaning solution)	Miami Lakes, Florida 33014 Phone: 305-430-0550
Modern Chemical Ohio Corporation www.a1.com/bluegold	Distributor of Blue Gold Aqueous Cleaner (Genesis approved aqueous cleaning solution for EAN/ Nitrox Service)	Batesville, Indiana 47006 Phone: (812) 934-5915
Simple Green www.simplegreen.com	Manufacturer of Crystal Green Aqueous Cleaner (Approved alternative aqueous cleaning solution for EAN/ Nitrox Service)	Huntington Harbor, CA 92649 Phone: (800) 228-0709
Sears Roebuck www.sears.com/craftsman	Retail distributor of Craftsman® tools	

GS2000 SPECIALTY TOOLS

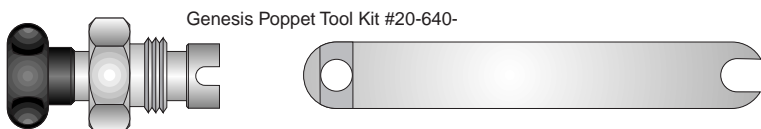
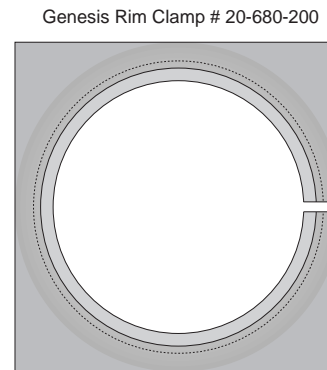
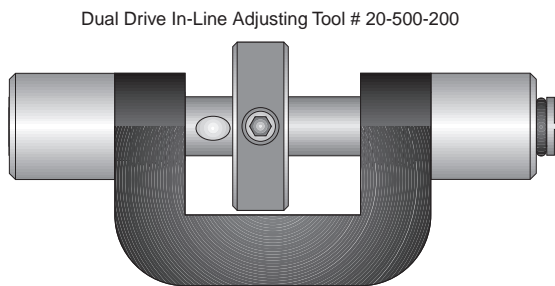
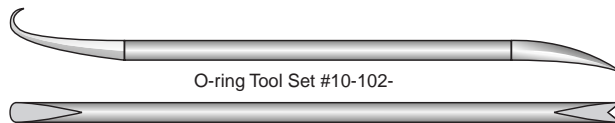
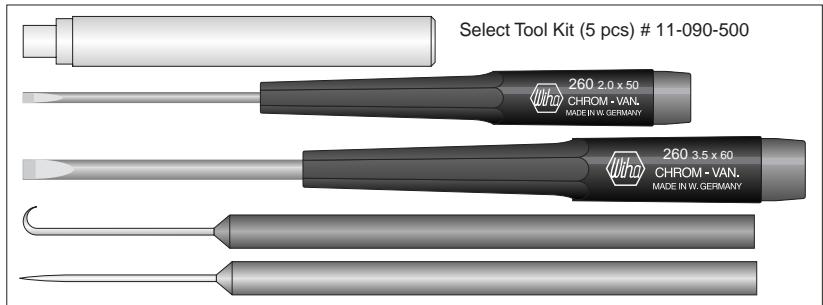
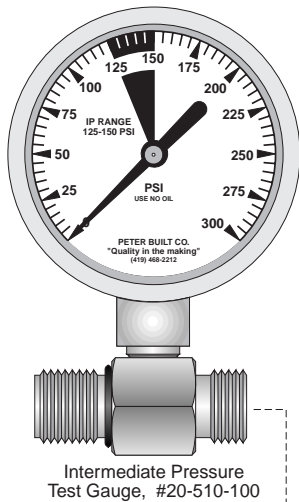

Genesis specialty tools are made in the USA by Peter Built Co. Illustrations courtesy of Peter Wolfinger.

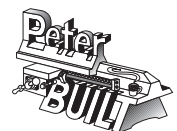

2

SECTION

PRELIMINARY INSPECTION

EXTERNAL INSPECTION

1. Closely examine the conical filter of the first stage to check for any signs that contaminants have entered the system, including sea water, rust, or aluminum oxide.



NOTE: A green discoloration positively indicates that moisture has entered the regulator, and internal corrosion may have occurred. Other types of discoloration may indicate that the regulator has been used with a corroded cylinder. Advise the customer of this, and the possible need to obtain service for their cylinder.

2. Slide back the hose protector(s) to inspect the condition of the LP hose at its fittings and along its length. Check closely for any signs of blistering or abrasion, or corrosion of the fittings.
3. Inspect the condition of the mouthpiece to check for torn bite tabs, holes, or deterioration.

IMMERSION / LEAK TEST

1. Check to ensure that the regulator is fully assembled and connected to a first stage, and that there are no open ports or hoses. Connect the first stage to a cylinder that is filled with 3,000 psi, and open the cylinder valve to pressurize the regulator.
2. If leakage cannot be heard, or if the source of leakage detected audibly is not obvious, immerse the second stage in fresh water to check further for any signs of air leakage through the mouthpiece and at the hose fitting.
3. Note the source of any leakage found and refer to *Table 2 - Troubleshooting* to determine its possible cause.
4. Close the cylinder valve and depress the second stage purge cover to depressurize the regulator.

▼ *After completing the Preliminary Inspection, proceed to **Section 3 - Disassembly***

DISASSEMBLY PROCEDURES

3

SECTION

GENERAL GUIDELINES

- ▼ *Prior to performing any disassembly, check to ensure that the service facility is well equipped with all the tools and parts needed to perform a complete service from start to finish. DO NOT attempt to perform the service unless all of the required tools and parts are available.*
- ▼ *All o-rings are classified as being either dynamic or static. **Dynamic** o-rings are those which sustain friction and movement, as they are either mounted directly onto a moving part, or create a seal against a moving part. **Static** o-rings simply create a seal between two non-moving parts, and are therefore less subject to wear than dynamic o-rings. After passing close inspection, static O-rings may sometimes be reused, although this is not necessarily recommended. Dynamic O-rings must be automatically discarded and replaced with every service, regardless of age or appearance.*
- ▼ *Refer to the schematic and parts list while performing these procedures. Each part is identified by its reference number shown on the drawing the first time it is referred to in the procedure.*
- ▼ *Do not attempt to reuse parts that are designated to be automatically discarded and replaced with the parts provided in the overhaul parts kit. These parts should be shown to the customer, however, to ensure their confidence and satisfaction that complete overhaul service has been performed.*
- ▼ *Inspect all reusable parts as directed, either during or immediately following the disassembly procedures. When in doubt, compare the part with one that is new to best determine its condition.*



Fig. 1 – Serial Number Location

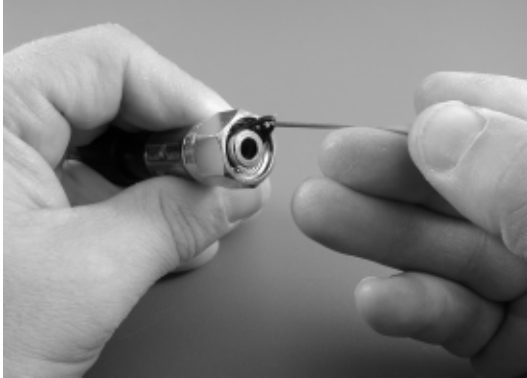

Fig. 2 – O-ring Removal



CAUTION: Whenever possible, use only plastic or brass O-ring tools for removing O-rings in order to prevent damage to the sealing surface. Steel instruments, such as dental picks, can easily damage the sealing surface of a softer brass part, causing irreparable leakage and requiring the part to be replaced with new.

1. Snip the plastic tie-strap(17) that holds the mouthpiece(15), and gently pull the mouthpiece off the second stage case(12). Record the serial number that is affixed directly below the mouthpiece tube, and compare it to the customer's invoice or service record to determine whether it is eligible for warranty service (see Fig. 1). Inspect the condition of the mouthpiece to ensure that it is supple and free of any tears or corrosion. If any damage is found that could result in discomfort or leakage, discard the mouthpiece and do not reuse.
2. Slide back the hose sleeve(41) to expose the connection of the LP hose(39).
3. While holding the inlet coupling(7) secure with a $\frac{3}{4}$ " open-end wrench, apply an $\frac{1}{16}$ " open-end wrench to the fitting of the LP hose. Turn the hose fitting counter-clockwise to loosen and remove.
4. Using the O-ring pick that is provided in the Select Kit (PN 11-090-500), carefully remove the O-ring(40) from the post inside the hose fitting (see Fig. 2).



CAUTION: The O-ring pick is made of steel and is very sharp, and is only recommended for the removal of O-rings that cannot be removed with a brass O-ring tool. When performing the above step, be very careful to avoid scratching the O-ring sealing surface. Doing so may cause a permanent leak that will require the replacement of the LP hose.

5. Turn the adjustment knob(26) completely out counter-clockwise only until resistance can be felt. While holding the diaphragm cover(2) depressed in the purge position, apply a $\frac{3}{4}$ " open end wrench to the inlet coupling and turn it counter-clockwise to loosen and remove.
6. Remove and discard the O-ring(8) from the inlet coupling. Do not reuse.
7. While holding the inlet coupling secure, apply a medium blade screwdriver to the slotted head of the valve orifice(6). Turn the orifice counter-clockwise until its threads have completely disengaged from the inlet coupling.



NOTE: The orifice is O-ring sealed and will remain inside the inlet coupling after performing the above step. The following step must be performed correctly in order to remove the orifice without damaging its polished sealing edge.

8. After the orifice has been unthreaded from the inlet coupling, stand the inlet coupling on end with the orifice sealing edge facing up. Carefully insert the handle of the blunt probe (provided in the Select Kit) through the top of the inlet coupling, directly over the sealing edge of the orifice. Gently press the orifice out (see Fig. 3).
9. To avoid using a sharp tool that can damage the orifice, squeeze the O-ring(5) between thumb and forefinger to remove it from the orifice head. Discard the O-ring and do not reuse.
10. Closely examine the orifice with the use of a magnifier, checking for any scratches or other damage to the sealing edge and the groove that holds the O-ring (see Fig. 4). If any damage or wear is found, discard the orifice and do not attempt to reuse. If it is in reusable condition, set it aside on a soft surface to keep it isolated from metal parts.
11. While holding the bottom of the second stage secure with one hand, firmly grasp the cover ring(1) with the other, and turn the ring counter-clockwise to loosen and remove.



NOTE: If the cover ring cannot be removed by hand, it may be necessary to use the Rim Clamp (PN 22-680-200), together with a bench-mounted vise. This Genesis specialty tool has been designed to prevent damage to the cover ring or the second stage during disassembly, but it must be used correctly, following the steps outlined below.

- a. Identify the side of the Rim Clamp that contains the larger diameter shoulder, which is designed to hold the GS2000 cover ring. Place the Rim Clamp between the jaws of a bench mounted vise with the larger diameter side facing straight up, and the split edge parallel with the vise jaws (see Fig. 5). Ensure that the top surface of the clamp rests slightly above or flush with the top surface of the vise jaws, and gently tighten the vise only until the clamp is held securely in place. Do not over-tighten or compress the clamp.
- b. Place the second stage inside the clamp, with the cover ring facing down. Tighten the vise to compress the clamp, only as far as is needed to secure the clamp around the cover ring to prevent slippage.

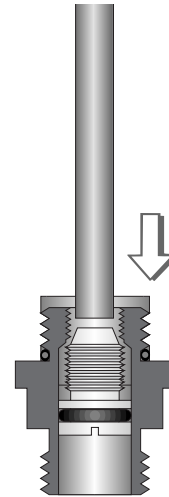

Fig. 3 – Orifice Removal



Fig. 4 – Orifice Inspection

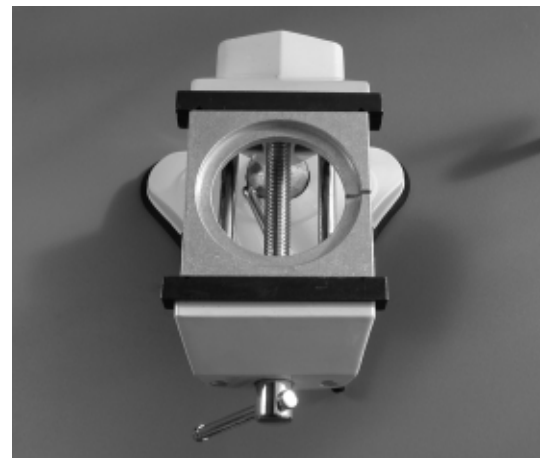

Fig. 5 – Genesis Rim Clamp



Fig. 6 – Cover Ring Removal

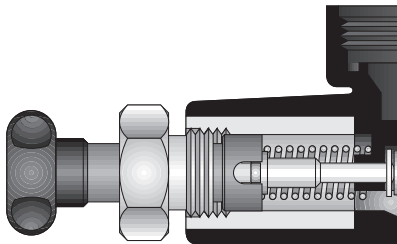

Fig. 7 – Genesis Poppet Drive Tool



Fig. 8 – Packing Nut Removal



Fig. 9 – Adjustment Stem Removal



CAUTION: Do not over-tighten the vise. Doing so may permanently distort or fracture the cover ring and the case, requiring their replacement.

- c. When the cover ring is held secure, firmly grasp the second stage with both hands and rotate the second stage counter-clockwise in a level direction above the clamp (see Fig. 6).
 - d. After loosening the cover ring, open the vise to loosen it further by hand to remove it.
12. Lift the diaphragm cover directly out of the case to expose the diaphragm(3), and closely inspect the cover to ensure it is perfectly round and free of any distortion or other damage. If any damage is found, discard the cover and replace with new.
 13. Grasp the diaphragm by the raised edges of the center plate, and lift it out of the case with a slight twist. Inspect the diaphragm to ensure it is supple and free of any pinholes, tears, corrosion, or other damage. If any damage is found, discard it and replace with new.
 14. Mate the Poppet Drive Tool (provided in the Genesis Poppet Tool Kit, PN 20-640-100) into the inlet tube of the second stage, and turn the knob slightly in either direction to engage the driver with the poppet(10). (See Fig. 7.) Then, turn the hex nut clockwise by hand until lightly snug to fasten the tool onto the second stage.
 15. Press the knob of the tool inward to compress the poppet spring until the arms of the lever(35) are visible, and pull the lever out of the second stage. Relax the tool. Examine the lever arm and compare with new to ensure that it is not bent or distorted in any way. Discard if damage is found.
 16. Ensure that the adjustment knob is turned completely out counter-clockwise, and apply a $3/32$ " hex key to the retaining screw(27). Turn the screw counter-clockwise to loosen and remove it, and then remove the knob.
 17. Apply a $5/8$ " box wrench or socket to the packing nut(25), and turn the nut counter-clockwise to loosen and remove (see Fig. 8).
 18. Hold the second stage over the workbench with the adjustment tube facing down, and press the Poppet Drive Tool inward to drop out the stem(22) with thrust washer(24) and O-ring(23), spring follower(21), balance spring(20), and spring pad(19). (See Fig. 9.)

19. Inspect the balance spring with a magnifier to check for any signs of corrosion. Discard it if corrosion is found, and do not reuse.
20. Remove the thrust washer from the adjustment stem and inspect it to check for any signs of wear or distortion. Discard if found, or set it aside to be reused if it is in satisfactory condition.
21. Remove and discard the O-ring from the adjustment stem. Do not reuse.
22. While holding the adjustment stem secure with one hand, turn the spring follower clockwise with the other to loosen and remove (see Fig. 10). Closely inspect the spring follower to check for any signs of wear or damage. Discard if found, or set it aside to be reused if it is in satisfactory condition.

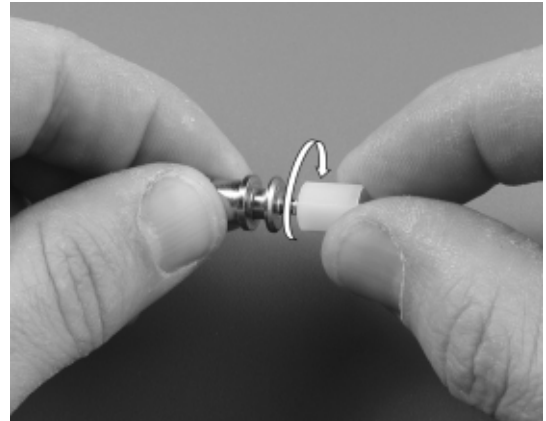

Fig. 10 – Spring Follower Removal



NOTE: The spring follower and adjustment stem are fastened together with a reverse (left-hand) thread. Clockwise rotation is required to loosen, and counter-clockwise rotation is required to tighten.

23. Press the adjustment tube into the second stage case, causing the balance shaft(32) to retract as it makes contact against the poppet shaft. Tilt the adjustment tube downward and lift it out to remove it from the case (see Fig. 11).
24. Insert the handle of the Blunt Probe (provided in the Select Kit) into the large end of the adjustment tube, causing the balance shaft to drop out. Inspect the balance shaft to check for any signs of damage, and set it aside to be reused if none are found.
25. Closely examine the small end of the adjustment tube to identify the snap washer(31) that is located inside the recessed opening. Insert the metal tip of the Blunt Probe at a slight angle through the center of the snap washer, and gently lift the washer out of the adjustment tube (see Fig. 12). Use the blunt probe in a similar fashion to remove the small O-ring(30). Discard both the snap washer and O-ring, and do not reuse.
26. Squeeze the O-ring(28) between thumb and forefinger to remove it from the adjustment tube. Discard the O-ring and do not reuse.
27. Closely inspect the features of the adjustment tube to check for any signs of damage to the sealing surfaces or male threads, and check to determine that the small hole in the



Fig. 11 – Adjustment Tube Removal



Fig. 12 – Snap Washer Removal



Fig. 13 – Disassembly of Poppet



Fig. 14 – Exhaust Tee Removal - Step 1



Fig. 15 – Exhaust Tee Removal - Step 2

opposite end is perfectly round and does not show any signs of wear or damage. If any wear or damage can be found, discard the adjustment tube and replace with new.

28. Apply the Poppet Nut Wrench (provided in the Poppet Tool Kit) to hold the locknut(33) secure. Engage the Poppet Drive Tool to turn the poppet counter-clockwise until the locknut falls off the end of the poppet shaft. (See Fig. 13.)
29. Turn the case over to drop out the spacer(34) and washer(36). Discard the washer and locknut, and do not reuse. Inspect the spacer to check for any signs of wear. If found, discard and replace the spacer with new, or set it aside to be reused if it is in satisfactory condition.
30. Unscrew the nut of the Poppet Drive Tool from the second stage inlet, and remove the tool to allow the poppet and poppet spring(11) to fall out. Inspect the spring with a magnifier to check for any signs of corrosion. Discard it if corrosion is found, and do not reuse.
31. Using the O-ring pick that is provided in the Select Kit, lightly pierce the center of the LP seat(9) and pull it out of the head of the poppet. Discard the seat and do not attempt to reuse.
32. Remove the exhaust tee(16) from the second stage case to expose the exhaust valve(18) for inspection.



CAUTION: It is important to follow the correct procedure for removing the exhaust tee. Failure to do so can result in permanent damage to the exhaust tee and the second stage case, requiring their replacement.

- a. First, place the blade of a medium screwdriver inside one of the openings of the exhaust tee, directly beneath the flange and in front of the tab (see Fig. 14). Press the flange between thumb and screwdriver and gently lift the flange straight up, only until it disengages from the tab. **DO NOT** pry at an angle.
- b. Repeat the above step to disengage the other flange.
- c. Hold the second stage case between both hands, and apply both thumbs to opposite sides of the exhaust tee. Press upward with equal pressure on both sides to disengage the exhaust tee from the two upper tabs of the case. (See Fig. 15.)
- d. Closely inspect the exhaust tee to check for any signs of damage that may have been caused by abuse or improper disassembly. If found, discard it and replace with new.



NOTE: It is not necessary to replace the exhaust valve unless it shows signs of wear or decay upon inspection. If replacement is not necessary, however, it is important to avoid removing the exhaust valve from the case while performing the inspection. Doing so will stretch the retaining barb, and can eventually result in leakage of water past the exhaust valve.

33. Closely inspect the condition of the exhaust valve to ensure that it is evenly seated against the second stage case on all sides, and free of any tears, holes, or other signs of decay. Peel back the lip on all sides to ensure it is supple and returns to its original position. If any wear or damage is detected, or if stiffening has occurred, pull the exhaust valve straight out of the case and discard it.
 34. Stand the case upside down with the mouthpiece tube facing forward. Wedge the tip of a 2mm screwdriver (provided in the Genesis Select Kit) against one end of the retaining ring(4) to prevent it from rotating around the groove of the dive/pre-dive switch(14). While holding it secure, apply the 3.5mm screwdriver to the other end of the retaining ring and press it through the mouthpiece tube (see Fig. 16).
 35. Gently press upward against the base of the dive/ pre-dive switch inside the mouthpiece tube, and pull it out from the opposite side to remove it from the case. Squeeze the O-ring(13) between thumb and forefinger to remove it from the switch, and inspect it to check for any signs of decay. Discard if found.
 36. Closely inspect the switch to check for any signs of damage – especially around the O-ring sealing groove, where a small scratch can allow the entrance of water into the second stage. Discard it and replace it with new if any damage is found.
 37. Closely inspect all features of the second stage case to check for any signs of damage or abnormalities, including the condition of the plastic threads and the area surrounding the molded metal insert inside the inlet tube. Cracking or cracks may be caused by exposure to extreme impact or stress, or aerosol sprays. If any damage is found, discard the case and replace with new during reassembly.
- ▼ After completing the disassembly of the second stage, proceed to **Section 4 – Cleaning & Lubrication**

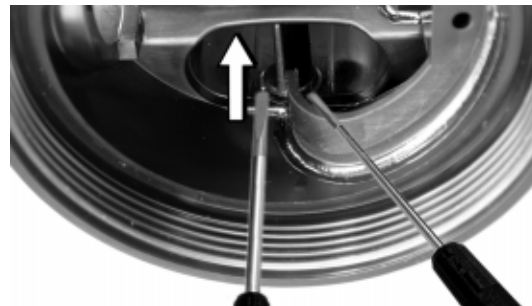

Fig. 16 – Retaining Ring Removal

4

CLEANING & LUBRICATION

SECTION

ACIDIC CLEANING PROCEDURE**(FOR EQUIPMENT USED WITH COMPRESSED AIR)****INTRODUCTION**

This procedure provides complete instructions for cleaning reusable, non-wearing components and parts of regulators and valves used with standard Grade E compressed air. Acidic Cleaning must also be performed as a prerequisite to performing Aqueous Cleaning — an additional procedure that is necessary for cleaning component parts of equipment used with mixtures of oxygen enriched air (EAN/Nitrox) containing more than 24% oxygen.

Acidic cleaning is a five step procedure that includes:

- ▼ *Degreasing and pre-scrub, plastic parts cleaning*
- ▼ *Tap water rinse*
- ▼ *Ultrasonic acid bath*
- ▼ *Sodium bicarbonate neutralizing bath*
- ▼ *Distilled or de-mineralized water rinse*

REQUIRED EQUIPMENT

- ❑ **Ultrasonic Cleaner** – Essential to provide the most effective removal of corrosion and scale from metal parts. It is impossible to attain the same level of cleaning with any other method. Preferred features include a built-in timer and a heater.
- ❑ **Screen Dip Basket** – Provided with most ultrasonic cleaners, allows the parts to be fully immersed in each solution, and transferred from one container to the next.
- ❑ **Separate Containers** – It is important to use four separate containers, including the well of the ultrasonic cleaner, to hold each solution so that the parts can be transferred quickly in the correct sequence and with minimal delay. Each container should be approximately the same shape and size as the well of the ultrasonic cleaner, so that the dip basket fits completely inside.

STEP 1 – Degrease & Pre-Scrub:

- ▼ All reusable non-wearing parts, both plastic and metal, should first be soaked and washed in a solution of 1 quart warm (100° F) water mixed with 3-4 tablespoons of household dish soap (Dawn® or Joy® are recommended). This will loosen and help to remove salt deposits and grime from plastic parts, and remove excessive residues of lubricant grease and grime from metal parts. This step will also extend the life of the acid bath solution by reducing the amount of contamination that occurs during cleaning.
- ▼ A nylon brush can be used to scrub stubborn deposits of grime and salt – especially for threaded metal parts and plastic parts.



CAUTION: DO NOT use a steel wire brush. Doing so can damage plating, threads, plastic parts, and sealing surfaces.

STEP 2 – Fresh Water Rinse:

- ▼ After completing Step 1, it is important to rinse all parts in fresh tap water to remove any soap residue, in order to prevent contamination of the acid bath solution.
- ▼ Step 2 completes the cleaning of all plastic parts.

STEP 3 – Ultrasonic Acid Bath:

CAUTION: It is important to carefully read and understand the Material Safety Data Sheet (MSDS) for any cleaning solution before using it, in order to be aware of the possible hazards associated with its use, and the necessary precautions that must be followed to avoid them.

- ▼ Genesis Scuba recommends Lawrence Factor Wash (LFW™) to be used exclusively for the acid bath cleaning of all non-wearing metal parts. LFW can be used in concentrated form, or can be diluted with up to seven parts distilled water to extend the life of the solution.
- ▼ For best results, LFW can be warmed to a temperature of approximately 120° F. Follow the directions provided on the label.
- ▼ For best results, soak parts in an ultrasonic cleaner for 5 to 15 minutes (depending on the strength of the solution), unless the finish is chipped or scratched. Parts with damage to their finish should be cleaned separately outside the ultrasonic cleaner to avoid agitation.
- ▼ Be certain to isolate more delicate parts, such as orifice cones, to prevent metal on metal contact with other parts or the dip basket that can cause damage to sealing surfaces.
- ▼ Use a timer to control the cleaning time, and do not leave parts unattended while they are inside the acid bath.



CAUTION: Harsh acids, such as muriatic acid, may cause damage to parts and must be strictly avoided. Undiluted white vinegar, although less effective, is the only recommended substitute for LFW™.

STEP 4 – Neutralizing Bath:

- ▼ Thoroughly mix ⅛ cup sodium bicarbonate (baking soda) with one quart fresh tap water in a clean container. Remove the parts from the acid bath, and immerse in this solution for 2-3 minutes.

STEP 5 – Final Rinse:

- ▼ Use only distilled water, to prevent mineral stains on the plated finish of newly cleaned parts.
- ▼ Agitate lightly, and then allow to soak for at least 15 minutes.
- ▼ Change the rinse often, to maintain a neutral PH.
- ▼ Dry the parts afterward with low pressure (50 psi) filtered air.
- ▼ Closely inspect all parts afterward to ensure they have been properly cleaned and are in like-new condition.

CLEANING TIPS:

- ▼ The yoke screw threads may be dipped into the acid bath, holding the plastic portion out of the cleaner.
- ▼ Be certain to isolate parts with critical sealing surfaces, including the orifice, to avoid harmful contact with other metal parts.
- ▼ If salt and corrosion buildup is severe around the hose fittings, immerse only the fitting of each hose in the acid bath cleaner, in order to prevent the solution from entering the hose. Rinse thoroughly in fresh water using the same method, and hang the hose to dry suspended in the middle with both ends hanging down. Blow low pressure (50 psi) filtered air through each hose prior to installing it onto the regulator.



NOTE: The parts are now clean for use with standard compressed air, not to exceed 24% oxygen content. Proceed directly to **Section 5 – Reassembly Procedures**, or proceed to the following page for additional cleaning instructions if the regulator will be serviced or upgraded for use with EAN/ Nitrox.

EAN/NITROX CLEANING PROCEDURE (FOR EQUIPMENT USED WITH OXYGEN ENRICHED AIR)

INTRODUCTION

Genesis Scuba regulators may be upgraded for dedicated use with mixtures of oxygen enriched air (EAN/Nitrox), not exceeding 40% oxygen. This upgrade must only be performed by an Authorized Genesis Dealer, and requires the installation of the first stage Nitrox overhaul/upgrade parts kit that is provided specifically for each model first stage regulator (refer to the schematic parts list).

Genesis Nitrox upgrade/overhaul parts kits contain O-rings, seats, and washers made of materials that are proven compatible with oxygen enriched air, up to 40% oxygen. It is very important to replace all standard replacement parts with those provided in each kit, and not to reuse any of them or replace parts individually under any circumstances.

The parts contained in each kit have been specially cleaned and packaged to ensure the absence of contaminants, and must be handled according to the instructions provided in this procedure to avoid accidental contamination.



NOTE: It is important to handle the contents of the Nitrox upgrade parts kits with care, wearing rubber or plastic gloves to prevent contamination with skin oil. In the event that contamination occurs, the parts must be cleaned according to the procedure outlined below.

Prior to the installation of a Nitrox upgrade/ overhaul parts kit, the regulator must undergo a complete overhaul service that includes special cleaning and parts inspection according to the steps outlined in this procedure. Special cleaning is necessary to remove contaminants from the regulator that may react with oxygen enriched air.

Standard compressed air usually contains a certain level of hydrocarbons, including invisible traces of compressor oil, that are not considered harmful or dangerous when kept within the acceptable limits for Grade E compressed air. When these same levels of hydrocarbons come in contact with oxygen enriched compressed air, however, they can pose a very real hazard that can lead to an oxygen fire or explosion. For this reason, it is important to clean the individual parts and components of any regulator or valve before it can be used with enriched air, in order to remove all traces of hydrocarbon contamination.

Although acidic cleaning is very effective for removing corrosion and scale, it is not sufficient by itself to remove certain sources of contamination. It is therefore necessary to perform an additional cleaning procedure that is specifically formulated to remove all traces of silicone grease, skin oil, compressor oil residue, and other hydrocarbon contamination.

EAN/Nitrox Cleaning is a four step procedure that includes:

- ▼ *Pre-Cleaning with Ultrasonic Acid Bath*
- ▼ *Ultrasonic Aqueous Cleaning Bath*
- ▼ *Distilled or Demineralized Water Rinse*
- ▼ *Final Inspection (direct light, ultraviolet, and wipe test)*



NOTE: Although second stage components are not usually exposed to high pressure oxygen enriched air, Genesis Scuba recommends that the same cleaning and assembly procedures be followed for the complete regulator. This prevents the possibility of cross contamination, and guarantees the integrity of the complete system.

REQUIRED EQUIPMENT:

- Dedicated Ultrasonic Cleaner** – To avoid contamination, it is important to use a separate cleaner that is kept dedicated for aqueous cleaning, in addition to one used for acidic cleaning. Preferred features include a built-in timer and a heater.
- Screen Dip Basket** – Provided with most ultrasonic cleaners, allows the parts to be fully immersed in each solution, and transferred from one container to the next.
- Powderless Latex Gloves** – Skin oil is another source of potential contamination that can react with oxygen enriched air. Once the parts have been cleaned, gloves must be worn at all times to prevent them from becoming contaminated during handling.
- Dedicated Rinse Tub** – To avoid recontamination, it is important to use a separate rinse tub that is kept clean and dedicated for aqueous cleaning, in addition to the rinse tub that is used for acidic cleaning.
- Incandescent or Fluorescent Lighting** – Required during final inspection to detect more obvious signs of contamination.
- Ultraviolet Lighting** – Required during final inspection to detect contamination that is not visible beneath normal lighting.
- Lint Free Cotton Wipes** – Required for cleaning and inspection.

PREPARING THE WORKSTATION

Enriched air cleaning procedures may be carried out in the same work area that is used for servicing air scuba equipment, provided that it is kept reasonably clean, and airborne pollutants (dust, soot, etc.) are not visibly present on surrounding surfaces. Ventilation ducts and windows should be checked to ensure that airflow will not introduce these contaminants while cleaning and service is in process.

- ▼ To ensure cleanliness, the work surface should be covered with a clean sheet of butcher paper or plastic sheeting.
- ▼ The technician must wear clean, non-powdered latex or plastic gloves whenever handling cleaned parts (including upgrade parts kit), in order to prevent contamination with skin oil.



NOTE: All tools and fixtures, including the ultrasonic cleaner well, must be kept completely clean of any contaminants. For this reason, a separate set of clean tools should be used for the reassembly of enriched air equipment, different from those used for normal air equipment.

ACIDIC PRE-CLEANING – Before performing aqueous cleaning, parts must first be cleaned with the acidic cleaning procedure outlined on page 15 to ensure the complete removal of any corrosion or scale. Final drying, however, is not necessary.



NOTE: Use only LFW™ cleaning solution, which contains an additional degreasing agent. White vinegar is not an acceptable cleaning agent for EAN/ Nitrox pre-cleaning.

ULTRASONIC AQUEOUS BATH



CAUTION: It is important to carefully read and understand the Material Safety Data Sheet (MSDS) for any cleaning solution before using it, in order to understand the possible hazards associated with its use, and the necessary precautions that must be followed to avoid them.

GENERAL GUIDELINES

- ▼ It is important to select an aqueous cleaning solution that is non-carcinogenic, non-toxic, and biodegradable, so that it can be safely disposed of by emptying it into a sewer system that is connected to a waste treatment facility. It must also be non-damaging to the materials of soft wearing parts, including seats, O-rings, washers, and gaskets. Last, it must be easily rinsed away so that it leaves no residue. Refer to Table 1 on Page 4, which lists the aqueous cleaning solution that Genesis Scuba has currently approved.
- ▼ The aqueous cleaning solution must be diluted only with distilled water, according to the ratio specified by the manufacturer.
- ▼ It is important to pre-heat the aqueous cleaning solution to approximately 130° F.
- ▼ The aqueous cleaning solution can be reused at least once, but will eventually require replacement as more contaminants and particulate matter are held in suspension. Frequently examine the appearance of the previously used solution in a clear beaker, and compare it alongside another beaker containing fresh solution in good lighting (diluted with the same ratio of demineralized water). When the appearance begins to vary between fresh and used, or when contaminants can be visually detected, the solution should be disposed of and replaced with new. Whenever in doubt, dispose of the solution and replace with fresh.

1. Place the parts inside a clean dip basket and lower the basket into the tank of a separate ultrasonic cleaner which contains an approved aqueous cleaning solution. (Refer to Table 1 for an approved and recommended solution, and follow the manufacturer's instructions for dilution rates and recommended working temperatures.) Be certain to isolate more delicate parts, in order to prevent metal on metal contact with other parts or the dip basket that can cause damage to sealing surfaces.
2. Before removing the parts, it is important to don clean powderless latex gloves in order to prevent any subsequent contamination with skin oils. Avoid touching the external surface of the gloves with bare fingers in the process of donning. Without this barrier present, parts will become contaminated with skin oil.



NOTE: It is important to avoid handling clean parts with bare hands while performing the rinsing, inspection, and reassembly procedures. Doing so will re-contaminate the parts with skin oil, and require them to be cleaned again prior to reassembly.

3. With a small, nylon brush and lint-free swabs, scrub all surfaces of each part, and allow to soak for an additional 5-10 minutes before removing from the ultrasonic cleaner. Certain parts with complex features may require more attention - especially those which contain closed recesses and chambers. It is important to ensure that these are thoroughly flushed with solution, and that contaminant residue is not trapped inside.

Demineralized or Distilled Water Rinse:



NOTE: Tap water drawn from the faucet often contains high levels of minerals, and is considered unsuitable for use with aqueous cleaning, either as a diluent or final rinse. Inexpensive filtration systems may be used which easily filter out most minerals, rendering the water "demineralized." For high volume operations, this is a less expensive alternative to bottled distilled water.

1. When immersion in the aqueous cleaner has been completed, it is extremely important to transfer all parts into a clean container filled with fresh distilled or demineralized water that is heated to approximately 140° F, to facilitate faster drying. Rinse each part thoroughly with mild agitation to ensure thorough rinsing and the complete removal of cleaning solution. Parts with more complex features will require additional attention to ensure complete rinsing of threads, crevices, and recesses.
2. Dry immediately afterward, using only low pressure (50 psi), hydrocarbon-free gas (Nitrogen or EAN).
3. When drying is completed, set the parts aside on a clean, lint-free surface covered with butcher paper or cellophane.

Final Inspection:

When each part has been completely cleaned and dried, it must be closely inspected to ensure the total absence of contamination or cleaner residue. In the event that contamination is still found during inspection, it may be necessary to re-clean the part. Inspection is a critical procedure that must be performed in three consecutive steps.

1. Gently wipe all surfaces of each part with a clean, lint-free wipe, and closely inspect both the wipe and part under strong fluorescent or incandescent light to check for any signs of scale, corrosion, damaged plating, burrs, filings, grease, fingerprints, oil, or other contamination. If contamination is found, repeat the above cleaning procedure or replace the part as needed.
2. Assuming no contamination is found, immediately inspect the same part and wipe under ultraviolet light to check for any signs of oils, grease, or fine particulate matter which will fluoresce (glow) if present. If found, repeat the aqueous cleaning procedure.



NOTE: Isolated particles of dust may be eliminated with low pressure, hydrocarbon-free gas.

3. Wrap or cover all metal parts with cellophane or other plastic until ready to begin reassembly.



NOTE: Before proceeding, clean fingertips of latex gloves with isopropyl alcohol to remove any contamination.

4. Examine each replacement parts kit to determine that it has not been previously opened, and that the individual parts have not been exposed to possible contamination, including handling with bare fingers.



WARNING: Do not attempt to use individually ordered spare parts as a substitute for those packaged in kit form directly from Genesis Scuba. Doing so will render the product incompatible for use with enriched air, and may seriously jeopardize the safety of the diver.

5. Closely inspect all new replacement parts for both the first and second stage, including O-rings, seats, filters, and gaskets, under fluorescent and ultraviolet light as prescribed above. Examine the condition of the O-rings to ensure they are in new condition, and do not show any signs of decay. If contamination is found, it will be necessary to re-clean the parts, following the procedures outlined above.

LOW PRESSURE HOSE ASSEMBLIES

1. Ultrasonically clean both hose fittings by dipping only the hose ends in the LFW™ acid bath, and rinse thoroughly in distilled water.
2. Inspect each fitting to ensure that all scale and corrosion is removed, and re-clean if necessary, using a small nylon brush.
3. Run aqueous cleaning solution through the hose in both directions, checking to ensure that no foreign matter or loose material exits the hose when it is drained. If evidence of internal decay is visible, discard the hose and replace with new.
4. Don clean, powderless latex gloves in order to prevent any subsequent contamination with skin oils. Avoid touching the external surface of the gloves with bare fingers in the process of donning. If contamination of a glove does occur, it can be cleaned with isopropyl alcohol.
5. Ultrasonically clean both fittings inside and out with aqueous cleaning solution, using a soft nylon brush and lint-free swabs to clean all surfaces, including threads, crevices, and recesses.
6. Thoroughly rinse the hose inside and out with heated, demineralized water, to completely remove all traces of aqueous cleaning solution.
7. Direct hydrocarbon-free gas through the hose until it is completely dry inside and out.
8. Inspect the hose according to the inspection procedure outlined in these instructions.
9. Set the hose aside on clean surface, and wrap both fittings with cellophane until it is ready for reassembly onto first and second stages.

LUBRICATION & DRESSING:

Perhaps the most critical component of any equipment used with oxygen enriched air is the lubricant grease. Regardless of the application, Genesis Scuba recommends Christo-Lube® MCG-111 (PN MS150) to be used exclusively for the lubrication and dressing of all O-rings and other internal parts. Christo-Lube® provides superior lubrication and protection to that of silicone grease, especially in high pressure (DIN) systems greater than 3,000 psi, and extreme temperature conditions.



CAUTION: Do not attempt to use silicone grease on any component, regardless of grade or manufacturer. Silicone grease is not suitable for use with oxygen enriched air, and will contaminate the entire system, rendering it non-compatible with EAN/ Nitrox.

- ▼ Wear clean, powderless latex gloves at all times while handling new O-rings and other parts, to avoid contaminating the parts with skin oil.
- ▼ Dress all O-rings with a visible film of Christo-Lube, but avoid applying excessive amounts, as this may attract particulate matter that can cause accelerated wear or damage to the O-ring.

- ▼ Set the O-rings aside on a perfectly clean surface that is covered with cellophane. Do not use lubricant that appears to be contaminated with any particulate matter or other foreign debris.



CAUTION: The use of aerosol spray or petroleum based lubricants must be strictly avoided. The propellant gas or petroleum base may attack or weaken plastic or rubber parts, and is not compatible with enriched air.

Final Adjustment & Flow Testing

When the equipment has been cleaned and reassembled, it is very important to avoid contact with standard compressed air, to prevent any possibility of hydrocarbon contamination. It is therefore extremely important to pressurize only with hydrocarbon-free gas for the purposes of final adjustment and flow testing. As a less expensive alternative to EAN, compressed Nitrogen may be used, purchased from a reputable gas supplier that can certify the gas as being hydrocarbon-free.



CAUTION: Do not connect the regulator to any cylinder or air supply that cannot be verified as containing hydrocarbon-free gas. If the regulator is pressurized with standard compressed air, which contains hydrocarbons, it will be rendered incompatible with enriched air mixtures above 23.5 percent oxygen until the above cleaning procedure has been repeated.

Labeling & Packaging

After performing the EAN/ Nitrox cleaning and service procedures, it is extremely important to ensure that each piece of equipment serviced is clearly labeled and identified for dedicated use with EAN/ Nitrox. This will help to prevent any crossover use with normal compressed air, and will also help to prevent any accidental use by untrained users.

- ▼ *After completing the cleaning procedures, proceed to **Section 5 - Reassembly***

5

SECTION

REASSEMBLY PROCEDURES

GENERAL GUIDELINES

- ▼ Refer to the schematic parts list, that highlights automatic replacement parts (ARP) which should be discarded and replaced with new during reassembly. ARP parts are provided in the Annual Service Kit.
- ▼ Before performing any reassembly, it is important to individually inspect all parts, both new and those that are being reused, to ensure that each part and component is perfectly clean and free of any dust, decay, or blemishes.
- ▼ Prior to dressing, inspect all O-rings with magnification to ensure they are supple, clean, and completely free of any scoring or decay that would impair proper sealing.
- ▼ Genesis recommends Cristo-Lube® MCG-11 (PN MS150) to be used exclusively for the lubrication and dressing of O-rings and other internal parts. Cristo-Lube® provides superior lubrication to that of silicone grease, especially in high pressure (DIN) systems greater than 3,000 psi, and extreme temperature conditions. It is also non-reactive to oxygen, and is approved for use with EAN/Nitrox.



CAUTION: Silicone grease is not compatible with oxygen enriched air, and must be strictly avoided when servicing a regulator that will be used with EAN/ Nitrox. The entire regulator will otherwise become contaminated, and rendered unsafe for use with any mixture of oxygen enriched air.

- ▼ Dress all O-rings with a visible film of Cristo-Lube, but avoid applying excessive amounts, as this may attract particulate matter that can cause accelerated wear or damage to the O-ring.



CAUTION: The use of aerosol spray or petroleum based lubricants must be strictly avoided. The propellant gas or petroleum base may attack or weaken plastic or rubber parts.

- ▼ If the regulator has been serviced or upgraded for use with EAN/Nitrox, it is important to don powderless latex gloves before handling any parts, including O-rings, in order to avoid contaminating the parts with skin oil.



WARNING: DO NOT attempt to use any other manufacturer's part as a substitute for any Genesis part, regardless of any similarity in shape, size, or appearance. Doing so may render the product unsafe, and could result in serious injury or death.

1. Install the O-ring(13) onto the dive/ pre-dive switch(14).
2. Mate the flat vane of the dive/ pre-dive switch into the case(12) above the mouthpiece tube, and position the indicator pin above the curved recess. Press the switch firmly into place so that it is fully seated inside the case.
3. Turn the case upside down with the open side facing forward. Lay the retaining ring(4) inside the mouthpiece tube, with its flat side facing up and the two ends facing directly toward the groove of the dive/ pre-dive switch. Check to ensure that the groove around the base of the switch is visible, and apply a 3.5mm screwdriver squarely behind the retaining ring to press it into place (see Fig. 16). Examine closely to ensure that the retaining ring is seated evenly inside the groove of the switch.



Fig. 16 – Retaining Ring Installation



CAUTION: It is important to ensure that the switch, O-ring, and retaining ring are correctly installed in order to maintain the watertight integrity of the second stage assembly. Failure to do so may cause the second stage to flood.

4. Install the exhaust valve(18), if it was removed, into the case by gently pulling the stem through the hole in the center of the sealing area, until the barb has passed through and is securely seated against the opposite side.
5. Fit the exhaust tee against the case, so that the slots in the top of the exhaust tee are resting directly over the tabs (see Fig. 17). Snap the top of the exhaust tee together with the case, followed by the two lower flanges. Check to ensure that all four tabs are securely locked into their slots.
6. Fit the LP seat(9) into the head of the poppet(10) with the smooth side facing out. Ensure that it is seated flush with the inner rim of the poppet. DO NOT use adhesive.
7. Stand the Poppet Drive Tool (provided in the Genesis Poppet Tool Kit – PN 20-640-100) on its knob, with the drive socket facing straight up. Index the tabs of the poppet head with the driver, and stand the poppet inside the tool with the shaft facing straight up.



Fig. 17 – Exhaust Tee Installation



Fig. 18 – Poppet Installation



Fig. 19 – Locknut Installation



Fig. 20a – Adjustment Tube Seating Shoulder



Fig. 20b – Adjustment Tube Installed

8. Apply a light coat of lubricant to both ends of the poppet spring(11), and place the spring over the poppet shaft.
9. While holding the Poppet Drive Tool stable, mate the inlet tube of the second stage case straight down over the poppet and spring, and hold it depressed so that the threads of the poppet are visible inside the case (see Fig. 18). Turn the hex nut of the tool clockwise by hand until lightly snug.
10. Place the washer(36) over the end of the poppet shaft, followed by the spacer(34).
11. Fit the locknut(33) into the closed end of the wrench provided in the Poppet Tool Kit, with the larger diameter end facing out. Hold the wrench with the nut mated against the threaded end of the poppet shaft, and slowly turn the knob of the Poppet Drive Tool clockwise to engage the threads (see Fig. 19). Continue turning the knob clockwise until exactly 3 threads extend outside the locknut, and then remove the wrench from the nut.
12. Place the snap washer(31) over the stem of the balance shaft(32), followed by the small O-ring(30).
13. Insert the stem of the balance shaft into the small end of the adjustment tube(29), and firmly press the large end inward so that the O-ring and snap washer seat securely inside the recessed opening.
14. Install the O-ring(28) onto the adjustment tube, inside the grooved flange nearest the threaded end.
15. Examine the flange near the center of the adjustment tube to identify the crescent seating shoulder (see Fig. 20a). While holding the adjustment tube with the center of this seating shoulder facing directly up, guide the threaded end into the case and through the opening until it appears outside. Grasp the threaded end between thumb and forefinger to pull the adjustment tube completely through, rotating it slightly in either direction, until the seating shoulder fits over the two ridges inside the case (see Fig. 20b).
16. Press the knob of the Poppet Drive Tool inward and hold it fully depressed to insert the arms of the lever(35) over the poppet shaft, between the spacer and washer. Slowly relax the knob, and watch to ensure that the lever stands completely upright as the poppet retracts into the inlet tube. Unscrew and remove the tool from the second stage.

17. Mate the spring follower(21) over the threads of the adjustment stem(22), and turn it counter-clockwise to tighten until finger snug (see Fig. 21).



NOTE: The spring follower and adjustment stem are fastened together with a reverse (left hand) thread. Clockwise rotation is required to loosen, and counter-clockwise rotation is required to tighten.

18. Install the O-ring(23) onto the groove of the adjustment stem, and stand the adjustment stem on end with the spring follower facing straight up.
19. Fit the secondary spring(20) over the end of the adjustment stem and press it into place so that it seats securely inside the recessed end of the spring follower. Then, place the spring pad(19) over the spring with its mating tab facing down.

20. Firmly grasp the second stage in one hand with the adjustment tube facing down and held securely in place between thumb and forefinger. Hold the adjustment stem with the other hand, and carefully guide the spring pad and spring up through the open end of the adjustment tube (see Fig. 22) until the spring follower is mated inside the hexagonal center of the adjustment tube. Then, while holding the adjustment tube securely seated, firmly press the end of the stem inward until the O-ring is seated inside the adjustment tube.

21. Install the washer(24) over the end of the adjustment stem, followed by the plastic packing nut(25). Turn the packing nut clockwise by hand until finger snug. Then, apply a torque wrench with a $\frac{5}{8}$ " hex socket to tighten the nut to a torque measurement of 12 (± 1) inch-lbs. (See Fig. 23). Be careful to avoid over-tightening.

22. Fit the adjustment knob over the end of the adjustment stem, and rotate it as needed to align the screw holes of both parts. Mate the retaining screw(27) through the hole in the adjustment knob and into the threaded hole of the stem, and turn it clockwise to engage the threads. Apply a $\frac{3}{32}$ " hex key to tighten the screw snug, and check to ensure that the adjustment knob is turned fully counter-clockwise to its minimum resistance position.

23. Install the O-ring(5) onto the head of the orifice(6), and insert the orifice into the open end of the inlet coupling(7) with the threaded end facing in. Apply the handle of the blunt probe to seat the orifice against the threads inside the inlet coupling (see Fig. 24).

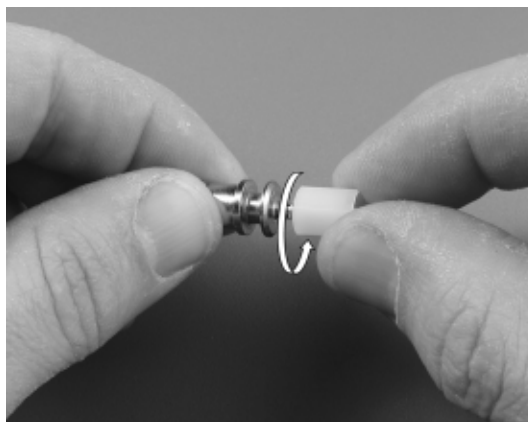

Fig. 21 – Spring Follower Installation



Fig. 22 – Adjustment Stem Installation



Fig. 23 – Packing Nut Installation

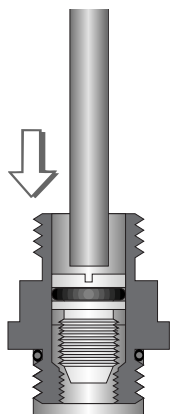

Fig. 24 – Orifice Installation



Fig. 25 – Orifice Preliminary Setting

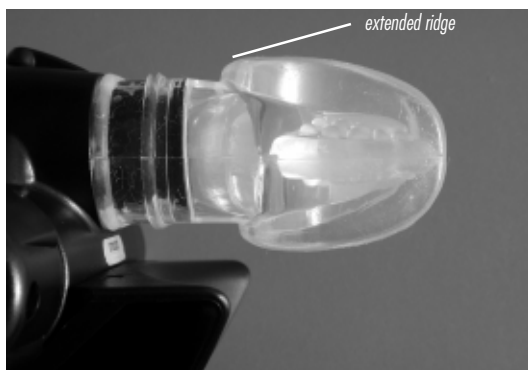

Fig. 26 – Orthodontic Mouthpiece Orientation

24. Install the O-ring(8) onto the short end of the inlet coupling, at the base of the threads closest to the hex feature. Mate the inlet coupling into the inlet tube of the second stage case, and turn it clockwise by hand to tighten until snug. While holding the second stage case secure, apply a torque wrench with a $\frac{3}{4}$ " hex socket to tighten the coupling to a torque measurement of 90 (± 5) inch-lbs.
25. Apply a medium blade screwdriver to engage the slotted head of the orifice, and turn it clockwise approximately 5 full revolutions. Then, grasp the screwdriver by the shaft, rather than the handle, for best sensitivity of touch. Continue turning the orifice very slowly while closely observing the locknut on the end of the poppet (see Fig. 25). STOP turning the orifice when the locknut begins to move slightly. This will indicate that the orifice has made contact against the LP seat.



CAUTION: Do not continue to turn the orifice further beyond the point where it makes contact with the low pressure seat. Doing so may damage the LP seat or sealing surface of the orifice, requiring their replacement, and can also result in an incorrect adjustment of the second stage.

26. Lay the diaphragm(3) inside the case, directly over the lever, with its raised surface facing up.
 27. Fit the diaphragm cover(2) inside the case so that it seats directly over the diaphragm. Adjust as needed to align the logo parallel with the inlet coupling and adjustment knob.
 28. Mate the cover ring(1) over the diaphragm cover and into the case, and turn it clockwise by hand until snug. Be careful to avoid over-tightening.
 29. Install the mouthpiece(15) onto the mouthpiece tube of the case, with the extended ridge facing up to accommodate the natural overbite of the human jaw (see Fig. 26). Fit a tie-strap(17) over the mouthpiece with the locking tab facing toward the inlet coupling, and cinch it completely snug. Snip off the excess strap that extends outside the locking tab.
- ▼ After completing the reassembly of the second stage, proceed to **Section 6 – Final Testing**

FINAL TESTING PROCEDURES

6

SECTION



CAUTION: If the regulator has been upgraded for use with EAN/ Nitrox, it is important to pressurize and flow test the regulator using only hydrocarbon-free gas. The regulator will otherwise become contaminated with hydrocarbons if normal compressed air is used. Industrial grade compressed Nitrogen is strongly recommended as a less expensive alternative to EAN/ Nitrox for the purposes of flow testing.

1. Connect the IP Test Gauge (PN 20-510-100) onto the inlet fitting of the Inline Adjusting Tool (PN 20-500-200), and mate the opposite fitting of the tool onto the inlet fitting of the second stage. Pull back the knurled knob to retract the slotted drive, and tighten the tool clockwise onto the inlet fitting only until finger snug.
2. Install the O-ring(40) onto the post inside the female fitting of the LP hose(39). Mate the female fitting of the LP hose onto the male fitting of the IP Test Gauge, and tighten the swivel nut clockwise until finger snug (see Fig. 27).
3. Install the O-ring(38) onto the male fitting of the LP hose, and install the hose into an intermediate pressure port of a first stage regulator that has been verified to be properly serviced, with a stable intermediate pressure of 140 (± 5) psi . Apply a torque wrench with a $\frac{9}{16}$ " crow-foot to tighten the fitting to 38 (± 2) inch-lbs.



Fig. 27 - Inline Adjustment Tool w/ IP Gauge



CAUTION: If the second stage has been cleaned and serviced for use with EAN/ Nitrox, it is important to connect it with a first stage that has also been cleaned and serviced accordingly, and to use only hydrocarbon-free gas while performing this procedure. Use of standard compressed air will otherwise contaminate the system.

4. Turn the adjustment knob fully out counter-clockwise, and then back 1½ turns.
5. Ensure that all the first stage ports are sealed, and connect the first stage with a filtered gas supply of 2,500-3,000 psi. Slowly open the supply valve to pressurize the regulator. Listen to verify that a leak can be heard from the second stage valve, and proceed to step 6.

- a. If airflow cannot be heard, it will be necessary to initiate a slight leak between the orifice and poppet. Press the knurled knob inward to engage the slotted drive of the Inline Adjustment Tool with the head of the orifice inside the inlet fitting. Then, turn the orifice slightly counter-clockwise while lightly depressing the purge cover to prevent wear on the seat. Do not adjust any further than is needed to establish a slight leak.



NOTE: If more than a slight adjustment is required to initiate a leak, it is important to check the adjustment of the locknut on the poppet shaft to verify once again that it is set correctly to its preliminary setting, as specified in Step 11 of the Reassembly Procedure.

6. Hold the drive of the Inline Adjustment Tool engaged with the orifice. While lightly depressing the purge cover, turn the orifice slightly clockwise a very small fraction of a turn. Pause after each adjustment to listen, and be careful to avoid over-adjusting beyond the point that the leak has stopped. When the leak has stopped, purge the second stage several times to ensure that it does not return. Observe the IP Test Gauge while purging the second stage to verify that it indicates a stable intermediate pressure after each cycle, with no creep or fluctuation.



CAUTION: Over-adjustment of the orifice can cause excessive spring load in the second stage valve, and may impair the regulator's performance.

7. While holding the second stage with the mouthpiece facing down, gently shake it up and down. Listen closely to determine whether any movement of the lever can be heard inside, indicating that the lever has dropped. If lever movement cannot be detected, proceed to step 8. Otherwise, perform the following steps to raise the lever:
 - a. Remove the cover ring, diaphragm cover, and diaphragm to expose the valve assembly.
 - b. Shut the supply valve and lightly depress the lever to purge the regulator of air. Remove the Inline Adjustment Tool and disconnect the LP hose.
 - c. While holding the lever depressed, apply a $\frac{3}{4}$ " open end wrench to remove the inlet fitting with orifice from the second stage. Be careful to protect the exposed sealing edge of the orifice.

- d. Fasten the Poppet Drive Tool (PN 20-640-100) onto the second stage inlet, and engage the driver with the head of the poppet.
- e. While holding the locknut secure with the Poppet Tool Wrench, turn the knob of the Poppet Drive Tool clockwise a small fraction of a turn. Do not over-adjust, since it is important to tighten the nut onto the poppet only as far as is necessary to remove the lever slack.
- f. Remove the Poppet Drive Tool and Wrench, and reinstall the inlet fitting with orifice into the second stage while holding the lever depressed. Tighten finger snug.
- g. Repeat the above steps as needed to remove the lever slack.
- h. Reinstall the diaphragm, diaphragm cover, and cover ring. Reconnect the LP hose, tightening by hand until snug, and repressurize the regulator with a filtered gas supply of 2,500-3,000 psi to check for leakage.



CAUTION: Over-adjustment of the locknut can cause excessive spring load in the second stage valve, and may impair the regulator's performance. If leakage returns after following the above steps, disassemble the second stage valve assembly and repeat the above procedure following a close inspection of the orifice and LP seat and reassembly.

8. When the second stage is properly adjusted with no leaks or lever slack, depressurize and purge the system to disconnect the LP hose.
9. If the inlet coupling was removed, apply a torque wrench with $\frac{3}{4}$ " socket to tighten it to a torque measurement of 90 inch-lbs (± 5).
10. Reconnect the LP hose to the inlet coupling, and apply a torque wrench with $\frac{1}{16}$ " crow-foot to tighten the LP hose fitting to a torque measurement of 55 inch-lbs (± 5).

Subjective Breathing Test

1. While the regulator is connected to a cylinder containing 2,500 – 3,000 psi and pressurized, turn the second stage adjustment knob completely out counterclockwise, and verify that a slight leak of airflow is present.
2. Slowly turn the adjustment knob clockwise to verify that the airflow stops between $\frac{1}{2}$ - 1 turn.
3. Turn the adjustment knob completely in clockwise to maximum opening effort, and depress the second stage purge to ensure that an adequate volume of air flows through the mouthpiece, sufficient to clear the second stage.

4. Turn the adjustment knob out counter-clockwise until a leak can be heard, and then back just until the leak stops. Breathe from the second stage.
- ▼ A properly serviced and adjusted regulator should deliver air upon deep inhalation without excessive inhalation effort, freeflow, or vibration. When exhaling, there should be no resistance or sticking of the exhalation valve. If any of these problems occur, refer to *Table 2 - Troubleshooting*.

Flowbench Testing (optional)

The Subjective Breathing Test, combined with the Intermediate Pressure Test, will sufficiently verify the regulator's performance in most circumstances. As an additional test, a Magnahelic flowbench can be used to verify the second stage opening effort, which should not exceed 1.0 column inches H_2O with the knob turned out counter-clockwise, or 2.5 column inches H_2O with the knob turned completely in clockwise.

External Leak Test

After first stage reassembly and final adjustment of the second stage has been completed, submerge the entire regulator in a test tank of clean water while pressurized with 2,500-3000 psi. Observe any bubbles arising from the submerged regulator over a one minute period. The recommended time is necessary due to slower bubble formation that occurs in smaller leaks. Disassemble the regulator at the source of the leak to check sealing surfaces, assembly sequence and component positioning in order to correct the problem(s).



NOTE: The location of extremely small leaks can best be detected by applying a soap solution to the leak area. Before disassembling to correct any leaks, rinse the entire regulator thoroughly with fresh water and blow out all residual moisture with filtered, low-pressure (25 psi) test gas. Refer to *Table 2 - Troubleshooting*.

- ▼ When the second stage has been adjusted and tested according to the prescribed procedures, close the cylinder valve completely, and purge the second stage to depressurize the system. Loosen the yoke screw to remove the first stage from the cylinder, and seal the dust cap over the inlet fitting. Disinfect the mouthpiece, and dry the regulator completely with a clean towel.

This completes the overhaul service procedures for the GS2000 Second Stage Regulator

TABLE 2 – TROUBLESHOOTING GUIDE

SYMPTOM	POSSIBLE CAUSE	TREATMENT
Freeflow or leakage (Adjustment knob turned in)	<ol style="list-style-type: none"> 1. Excessive intermediate pressure. 2. Damaged or worn LP seat(9). 3. Damaged orifice(6) sealing surface. 4. Damaged orifice O-ring(5) 5. Orifice incorrectly adjusted. 5. Locknut(33) incorrectly adjusted. 7. Poppet spring(11) damaged. 8. Lever(35) is bent. 	<ol style="list-style-type: none"> 1. Refer to first stage troubleshooting guide 2. Replace with new. 3. Replace with new. 4. Replace with new. 5. Reset to preliminary setting and readjust. 6. Reset to preliminary setting and readjust. 7. Replace with new. 8. Replace with new.
Excessive Inhalation Resistance or Hesitation (Adjustment knob turned out)	<ol style="list-style-type: none"> 1. Insufficient intermediate pressure. 2. Locknut(33) incorrectly adjusted. 3. Orifice(6) incorrectly adjusted. 4. Lever(35) is bent. 	<ol style="list-style-type: none"> 1. Refer to first stage troubleshooting guide 2. Reset to preliminary setting and readjust. 3. Reset to preliminary setting and readjust. 4. Replace with new.
Insufficient airflow when purge button is depressed	<ol style="list-style-type: none"> 1. Lever(35) is slack, locknut(33) or orifice(6) incorrectly adjusted. 2. Lever is bent. 	<ol style="list-style-type: none"> 1. Reset to preliminary settings and readjust. 2. Replace with new.
Water entering second stage	<ol style="list-style-type: none"> 1. Exhaust valve diaphragm(18) worn or damaged. 2. Mouthpiece(15) worn or damaged. 3. Pre-dive switch(14) or O-ring(13) damaged, incorrectly installed, or worn. 4. Adjustment tube(29) or O-ring(28) damaged, incorrectly installed, or worn. 	<ol style="list-style-type: none"> 1. Replace with new. 2. Replace with new. 3. Disassemble and inspect, replace or reassemble as required. 4. Disassemble and inspect, replace or reassemble as required.



CAUTION: All repairs must be performed with a complete overhaul service, unless the problem is detected immediately after a complete overhaul service has already been performed. Do not attempt to perform partial service if the regulator shows any signs of use. For additional troubleshooting assistance, contact your Genesis Scuba distributor.

SCHEMATIC & PARTS LIST
GS2000 SECOND STAGE
(EAN/NITROX & COMPRESSED AIR)

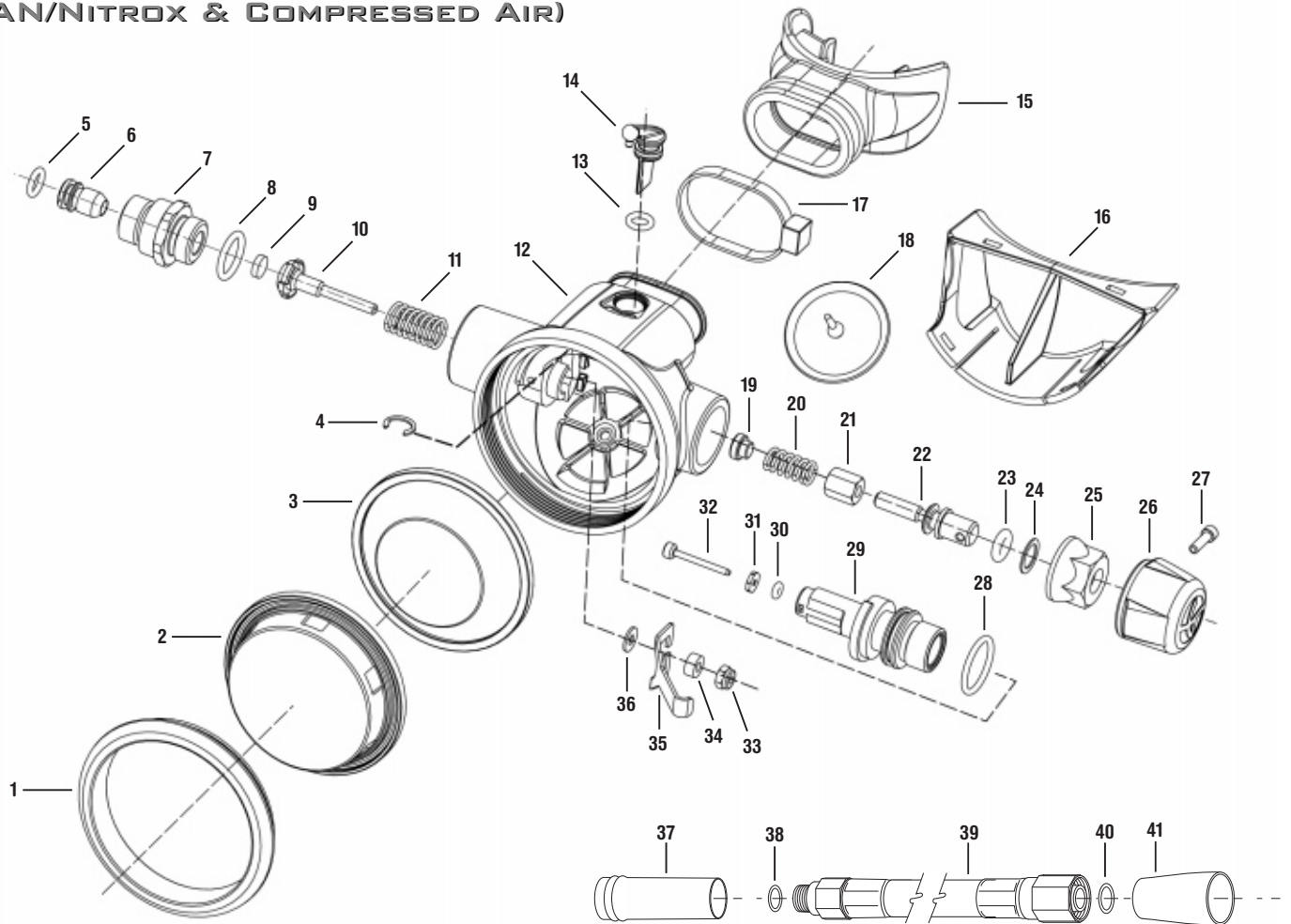

Ref #	PN	*ARP	Qty	Description
.....	PK050	-	-	Annual Service Kit
.....	PK050T	-	-	Cold Water Upgrade Kit
.....	GR050	-	-	GS2000 Second Stage, Assembled
1 G5252		1	Cover Ring - Metal
2 G5239-07A		1	Diaphragm Cover
3 G5236		1	Diaphragm
4 G5251	✓	1	Retaining Ring
5 G2-010	✓	1	O-ring
6 G6621		1	Orifice
7 G4330		1	Coupling
8 G3-906	✓	1	O-ring
9 G4340	✓	1	LP Seat
10 G4333		1	Poppet
 G4333T		1	Poppet, Cold Water
11 G4593		1	Poppet Spring
12 G5248		1	Case
13 G2-009	✓	1	O-ring
14 G5250		1	Dive/ Pre-Dive Switch
15 G4485-07		1	Mouthpiece
16 G5234		1	Exhaust Tee
17 G1978-07	✓	1	Tie-Strap
18 G6326		1	Exhaust Valve
19 G4971		1	Spring Pad

Ref #	PN	*ARP	Qty	Description
20 G4589		1	Secondary Spring
21 G6331		1	Spring Follower
22 G6330		1	Stem
23 G2-107	✓	1	O-ring
24 G5054		1	Thrust Washer
25 G6332		1	Packing Nut
26 G5238		1	Adjustment Knob
27 G4787		1	Retaining Screw
28 G2-016	✓	1	O-ring
29 G5245		1	Adjustment Tube
30 G2-004	✓	1	O-ring
31 G4969	✓	1	Snap Washer
32 G5244		1	Balance Shaft
33 G4336	✓	1	Locknut
34 G4335		1	Spacer
35 G5254		1	Lever
 G5245T		1	Lever, Cold Water
36 G5117	✓	1	Washer
37 G6653		1	Hose Protector
38 G3-903	✓	1	O-ring
39 G5253-30		1	LP Hose, 30 Inch
40 G2-010	✓	1	O-ring
41 G6325		1	Hose Sleeve

* ARP indicates Automatic Replacement Part - Provided in Annual Service Kit