



*SR2 Service Manual  
- First Stage -*



## **INTRODUCTION**

The instructions set forth in this document are intended to guide the experienced scuba equipment repair technician through the standard service procedure for this regulator.

It is assumed that the technician possesses basic scuba equipment repair training, proper tools and the skill necessary to perform the service. If you have not received regulator service training provided by Sherwood Scuba specifically for this equipment, do not attempt to perform the service described in this document.

Service parts for Sherwood equipment are sold only to Authorized Sherwood Dealers.

Before attempting to perform service read this manual in its entirety. There are warnings and cautions contained in the manual that may affect your safety or the safety of the regulator user.

If you are uncertain as to whether you are qualified to perform this service contact your regional Sherwood Scuba Distributor for technical assistance.

## **USE OF WARNINGS, CAUTIONS AND NOTES**



**WARNING:** Indicates a potentially hazardous condition or situation which, if not avoided, may result in serious injury or death.



**CAUTION:** Indicates a potentially hazardous condition or situation which, if not avoided, may result in minor injury. It may also be used to alert against unsafe practices.



**NOTE:** Indicates an important point or reminder

## **REGISTRATION, INSPECTIONS AND SERVICES ON-LINE REGISTRY.**

All Sherwood regulators have to be registered right after purchase, either by the end consumer or the dive center where the item was acquired. If the dive center is not capable to register the product for the end-consumer at the time of purchase, the sales associate from the dive center has to strongly encourage the end-consumer to register the product as soon as possible.

Effective immediately: recording inspections and services is required to ensure the proper continuity of the warranty process. Regardless of location, proper record keeping by the authorized dealer is required right after each inspection or service is performed.

When the regulator is going to be used for recreational purposes a year or 150 dives after purchase an inspection is required; a year after such inspection or when the regulator has completed 300 dives a full service is required. Time frames may be different when the regulators are going to be destined for public service, rental or instructional use. Please contact your local Sherwood Sales representative for additional information to discuss particular cases and usage.

Registration, services and inspections must be recorded at our website:

Go to [www.sherwoodscuba.com](http://www.sherwoodscuba.com), sign in using your dealer credentials, & locate the Product Warranty tab and follow the instructions to record inspections and services:



**Add a Service Date:**

Please enter the customer's email address or product serial number to find warranty:

*(ask your sales rep if you have questions regarding on-line event recording).*

## **WHEN TO SERVICE**

This regulator should be **inspected at least annually**. In most cases a simple inspection, and if needed, minimal adjustment not requiring the replacement of parts will be sufficient for continued use. Guidelines for the Annual Inspection are included in this manual.

This regulator is designed and tested to perform acceptably under typical recreational diving conditions up to 300 hours of use.

If the regulator has been subjected to **more than 300 hours of use, a year has passed since the last inspection** or it has not received the benefit of careful post-dive cleaning and storage in a clean environment, a **standard service overhaul** is required.

In any case the regulator should receive a standard service overhaul **at least every two years** to maintain optimal performance. The standard service overhaul includes disassembly, cleaning, inspection, replacement of seals, lubrication, reassembly and adjustments.

Sherwood Scuba offers a standard service kit that contains the parts recommended to be replaced in combination with the standard service overhaul.

## **ANNUAL INSPECTION GUIDELINES**

1. Visually inspect the first and second stage for signs of damage or deterioration. Mouthpieces with tears or other damage should be replaced.
2. Retract hose protectors and inspect the hose over its entire length for signs of damage including blisters, deep cuts or separation at the crimped fittings. If these signs are present the hose must be replaced and standard service overhaul is recommended.
3. Insert a soft probe through the exit port of the exhaust cover and lift the Exhaust Valve to inspect it for cuts, tears or contaminated surfaces. Perform this examination from both sides of the Exhaust Cover to observe the entire perimeter of the Exhaust Valve. If damage to the Exhaust Valve is found a complete overhaul is recommended. If the Exhaust Valve or the sealing surfaces on the Housing are contaminated with debris, the Exhaust Cover must be removed and the surfaces must be cleaned. Instructions for removing and replacing the Exhaust Cover appear in the Second Stage Service Guide. As a final check of the Exhaust Valve apply a moderate suction (approximately minus 5 inches of water, moderate inhalation effort) to the second stage mouthpiece with the air supply closed and the second stage purged. If leakage is detected a complete overhaul is recommended.
4. Inspect the first stage filter for evidence of contamination. Discolored filters indicate previous contact with contaminated air. If evidence of contamination is present it is recommended that a standard service overhaul be performed. In addition you should advise the customer that the regulator has been exposed to contamination and that previously used air cylinders used should be inspected.
5. Install an intermediate pressure gauge into one of the available LP ports.
6. Pressurize the regulator to approximately 500 psi and inspect for leakage. If air leakage through the second stage is detected, it is possible that the second stage Orifice is not in position to create a seal. Close the valve to stop the air flow and reopen quickly. This will generate enough sudden pressure to move the Orifice to its proper position. Note intermediate pressure. It should not be greater than 145 psi. If no leakage is detected increase pressure to 3000 psi. Again check intermediate pressure. It should not exceed 145 psi. The specified intermediate pressure for the SR1 & SR2 is 135+/- 10 psi. If intermediate pressure is out of range or leakage is present a standard service overhaul is recommended.
7. With the second stage Control Knob set at the least sensitive position (rotated fully clockwise) test the purge function. If there is not a strong surge of air, a standard overhaul is recommended.
8. Gently submerge the entire regulator and look for bubbles that indicate leakage. If leakage is present a standard service overhaul is recommended.
9. If a test bench is available perform an inhalation test. With the Control Knob in the most sensitive position (rotated fully counterclockwise) inhalation effort should not be greater than 1.5 inches of water at opening and less than 4.0 inches of water at 1.5 SCFM. If there is a slight leakage of air present refer to Adjustments Section of this manual and adjust as needed. If adjustment fails to stop the leak a standard overhaul is recommended. If a test bench is not available perform a subjective breathing test. When properly adjusted the regulator should provide smooth and easy inhalation. If difficulty with inhalation is suspected a standard overhaul is recommended.

## **GENERAL COMMENTS**



**NOTE** – Read this section before attempting to perform service.

1. Read the entire set of procedures that follows before starting to service. Steps taken out of sequence or without the knowledge of the proper procedure could damage the regulator or otherwise complicate the service process.
2. Refer to the Illustrated Parts List while performing service. Each part is identified with a reference number the first time it appears in the text. Parts that are to be replaced with new parts in conjunction with an overhaul have encircled reference numbers.
3. Do not attempt to reuse parts that are designated for replacement. Retain discarded parts to show to the customer to illustrate that a full overhaul service has been completed.
4. Work in a clean properly equipped area. Cleanliness is essential for all regulator servicing and is critical for regulators that will be exposed to enriched air mixtures (Nitrox). Do not attempt to service if all required tools and a clean work area are not available.
5. Work on one regulator at a time taking care not to mix parts from other regulators. Use only genuine Sherwood parts. Parts that appear similar may have different features that are not easy to detect and may cause poor performance.
6. Be careful to protect the finish on all surfaces of the regulator during the service procedure. When holding parts in a vise use soft or padded jaws to prevent defacing surfaces.
7. O-rings are classified by the service they perform and are identified as either **static** or **dynamic**. **Dynamic** O-rings are those that are subjected to movement and the effects of friction which tend to shorten the useful life of the O-ring. **Static** O-rings are used to create a seal between non-moving parts and are not subject to the same wearing effects. **Static** O-rings have a longer useful life and are not replaced unless they show signs of deterioration or brittleness. Careful inspection of these O-rings is required before they are returned to service.
8. When removing O-rings use a wooden, plastic or a soft brass tool to lift the O-ring out of its groove. Do not use steel or other hard tools that might scratch sealing surfaces.
9. When instructed to use tools such as a hex key or a wrench, follow the standard convention to rotate clockwise to tighten and counterclockwise to loosen unless otherwise directed.
10. When instructed to tighten a part until snug, it means to apply torque just until the part stops moving freely and the torque requirement to advance it further rises markedly. When specific torque specifications are given there is a necessity to ensure that the part is tightened enough to retain position or to create a seal. Unless you are skilled at accurately estimating torque, a torque wrench should be used. Excessive torque may damage parts and require replacement.

## **ENRICHED AIR NITROX SERVICE**

The SR1 & SR2 has been designed and manufactured to allow the use of Enriched Air Nitrox (EAN) gas with an oxygen component not to exceed 40%.

In order to maintain this option the user must ensure that the regulator is protected from the introduction of hydrocarbons. The introduction of hydrocarbons into the regulator may increase the risk of fire when used with EAN.

When servicing the regulator, the technician must be aware of this requirement and exercise caution not to contaminate the regulator with hydrocarbons. This requires a clean workplace, free of oil, grease, debris and other contaminants. Additionally in order to return the regulator to EAN service, the overhaul procedure must have a cleaning provision to remove all hydrocarbons before the regulator is reassembled. Do not substitute parts or use lubricants other than Tribolube 71 or Christo-Lube MCG 111. Silicone lubricants are **NOT** acceptable and increase the risk of a fire hazard.



**WARNING** – The introduction of hydrocarbons, lint, dirt and other contaminants into the areas of the regulator subjected to high pressures (greater than 500 psi) and EAN mixtures containing more than 40% oxygen may constitute a fire hazard and may subject the user to serious injury.

## **FACILITY REQUIREMENTS**

The service facility is perhaps the most important asset of any professional dive store. It should be clean, well lighted, and stocked with a complete inventory of parts and manufacturer's specialty tools for the products your store sells. As a minimum requirement, your service facility should be equipped with the following items:

- **Ultrasonic Cleaner** - Select the right size model that can keep up with the volume of regulators that your store services. A built-in timer and heater will help control the cleaning time and temperature of the solution, since most solutions work best when heated.
- **Bench Mounted Vise** - A vise is sometimes needed to hold the regulator secure – especially when removing the first stage yoke retainer. Special care must be taken, however, to avoid damage that can result from improper use of this tool. Be sure to follow the instructions provided in this manual.
- **Magnification Lamp** - Strong lighting and magnification are essential requirements for performing a thorough parts inspection - especially when locating the cause of a small leak.
- **Quality Wrenches & Sockets** - When working with chrome plated brass parts, it is especially critical to use the correct size wrench and to ensure that it fits properly over the part. The use of an adjustable wrench is very likely to cause damage to your customer's regulator, and should be strictly avoided at all times.
- **Calibrated Inch-Pound Torque Wrench** - it is important to follow the manufacturer's torque values whenever they are specified, in order to avoid overtightening or under tightening a part. This is especially important for smaller parts and fittings, when overtightening can easily damage the part.
- **Calibrated Foot-Pound Torque Wrench** - Torque wrenches that can be set for both inch-pound and foot-pound measurements generally tend to be less accurate than wrenches that are designed to measure torque within a specific range.
- **Manufacturer's Specialty Tools** - Specialty tools are critically important to performing each step of disassembly and reassembly according to each manufacturer's procedures. Sherwood specialty tools are required to perform service for the SR1 first stage are listed on the following page.

## **RECOMMENDED TOOLS AND SUPPLIERS**

The specialty tools identified below may be purchased from your Sherwood Scuba Distributor. Common tools are available from several sources.

### ***Common Tools***

Open End Wrenches - 9/16", 5/8", 1/2"  
 Box End Wrench – 3/4"  
 Hex Keys 1/4", 5/32", 1/8"  
 Small Flat Blade Screw Driver  
 Padded Pry Bar  
 Torque Wrenches 25 ft-lb and 60 in-lb  
 Flashlight  
 Airgun  
 1/4" x 6" Plastic Probe  
 O-ring picks/ small probes, plastic or soft metal  
 Magnifier

### ***Specialty Tools***

SR1 Tool Kit 20-700-100

***Includes the following:***

HP Seat Retainer Tool	20-750-150
Cover Retainer Tool	20-622-100
Piston Stem O-ring Tool	20-685-400
Poppet/Flange O-ring	20-626-400
Installation Tool	

Available specialty tools not included in the kit.

First Stage Spanner	20-600-200
First Stage Handle	20-115-100
Yoke Retainer Socket	20-155-500
Breaker Bar	20-157-500
Snap Ring Pliers	10-101-500
3/8" Drive x 3" Extension	20-156-500

# SECTION 1

## DISASSEMBLY PROCEDURE

1. Record the First Stage and Second Stage serial numbers and an inventory of all attached accessories before beginning disassembly.
2. Perform an inspection of the regulator in accordance with the Annual Inspection Guidelines. This process will give the technician a reference point if after the overhaul the regulator does not perform as expected.
3. Remove all hoses attached to the first stage with a 9/16" open end wrench for the LP Hose and a 5/8" open end wrench for the HP Hose. BCD Inflator hoses typically require either a 9/16" or 1/2" open end wrench. Tag all hoses that attach accessories such as gauge consoles to ensure they are returned to the appropriate regulator port when reassembled.
4. Remove all port plugs (**11** & **21**) including the port plug in the end of the Port Swivel (**24**) with a 5/32" hex key. Remove and inspect O-rings (**22** & **10**). Replace if signs of damage or deterioration are present, otherwise set aside for cleaning and reassembly.



**NOTE** – In order to avoid the risk of damage to the regulator finish during the disassembly process the preferred method is to secure the first stage body in a bench vise without direct contact between the vise jaws and the regulator. The First Stage Handle (P/N 20-115-00) or similar device is recommended to mount the regulator securely without contact between the vise and the regulator body. An alternative method is to use a woodworking vise with soft jaws to minimize the risk of damage to the regulator finish.

***If the first stage has a yoke type connector go to steps 5 through 7. If the first stage is a DIN type, go to step 9.***

5. With the Body secured in a padded vise, loosen the Yoke Screw (**30**) to create enough space to fit a 1" Yoke Retainer Socket (PN 20-155-500) inside the Yoke (**31**) and over the Yoke Retainer (**34**). Pass the Breaker Bar (PN 20-157-500) through the Yoke and engage the socket. Tighten the Yoke Screw sufficiently to secure the Breaker Bar and rotate the Breaker Bar counterclockwise to loosen the Yoke Retainer.



**CAUTION** – The socket and breaker bar combination provide the best means to prevent damage the Yoke Retainer during disassembly. DO NOT use an adjustable wrench or open end wrench that does not properly fit over the flats on the Yoke Retainer. Doing so may result in permanent damage to the Yoke Retainer or other parts.





6. Remove the Yoke Retainer, Inlet Protector (36), Yoke Saddle (37) and Yoke.
7. Separate the Yoke Screw from the Yoke and set aside for cleaning.
8. Yoke Retainer Disassembly - While holding the Yoke Retainer securely, use a pair of Snap Ring Pliers (PN 10-101-500) to compress the Retaining Ring (32) and remove it from the groove inside the Yoke Retainer. Remove and discard the Filter (33). Remove and inspect O-ring (35). Discard it if it shows signs of deterioration, otherwise set it aside for reassembly.

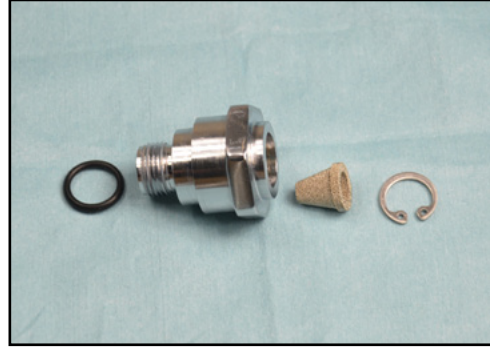

9. DIN Connector Disassembly –

- a. Insert a 1/4" hex key into the DIN Filter Retainer (39) and rotate it counterclockwise to remove it. Remove the DIN Wheel



- b. Remove the DIN Filter Housing from the Body with a 9/16" open end wrench. Once removed, invert it to allow filter to slide out of the filter Housing.

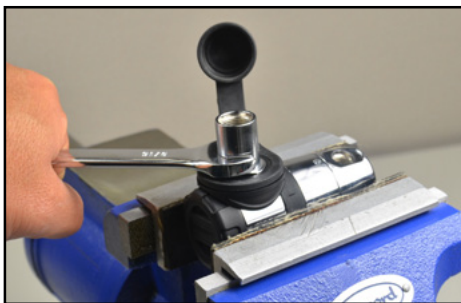

- c. If rotating the hex key results in the DIN Filter Housing and DIN Filter Retainer separating from the Body as a unit, this is acceptable. Place the DIN Filter Housing in a vise clamping over the flats on the largest diameter on the DIN Filter Housing. This will stabilize the DIN Filter Housing to allow further rotation of the DIN Filter Retainer to separate the two parts and provide access to the Filter. Discard the Filter.



- d. Remove and discard O-ring (**38**). Set aside the Din Handwheel (41), O-rings (**35**), DIN Inlet Protector (**42**)



10. Secure the Body (**9**) to gain clear access to the cap/swivel combo. Fit the First Stage Spanner into one of the lateral holes in the End Cap (**26**) and rotate the End Cap counterclockwise when viewed from the Port Swivel.



11. Use tool 20-115-100 to stabilize the LP Ports. Place 1/4" hex key in the Swivel Retainer and rotate counterclockwise to separate the End Cap from the Port Swivel. Remove and discard two O-rings (**7** and **25**). Remove Washer (**27**) and Accent Ring (**23**) and set aside for later reassembly.

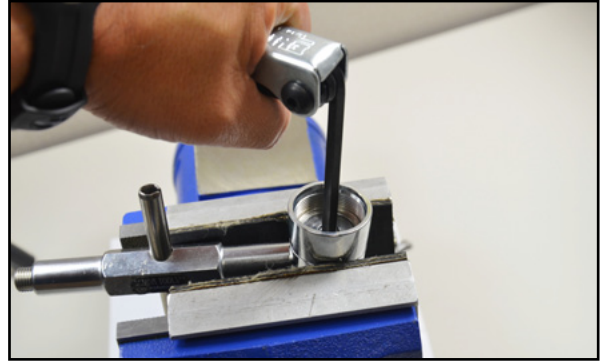
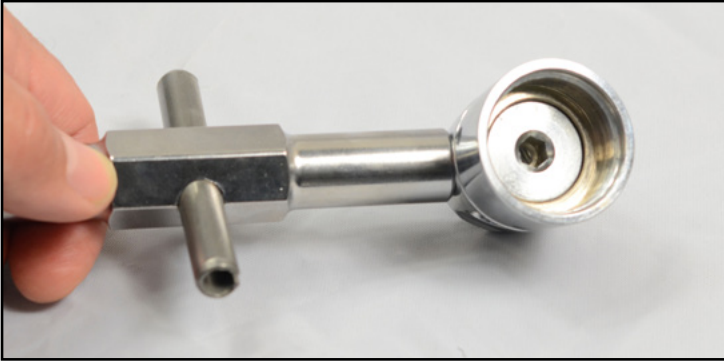

12. Remove the Diaphragm Retainer Cap (**20**) turning it by hand counterclockwise. If necessary the First Stage Spanner may be used to loosen it. Remove the Dry Chamber Diaphragm (**19**) and Pressure Plate (**18**). Inspect the Dry Chamber Diaphragm and replace it if there is evidence of damage or deterioration, otherwise set it aside for cleaning and reassembly.
13. Using a 9/16" x 3/8" socket secure stainless steel seat retainer tool (20-750-150); the tool mounted in the socket could be used permanently to facilitate the use of a ratchet or torque wrench.



14. Use tool 20-115-100 on one of the HP Ports of the first stage and secure it in the vise. Remove the Seat Retainer (**17**) by rotating it counterclockwise with the Seat Retainer Tool and socket.



15. Use shop air pressure (less than 125 PSI) applied at the small orifice located in between the spanner slots on the Seat Retainer to dislodge the Seat (**16**). Discard the Seat.

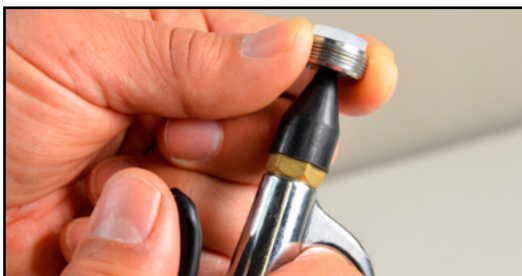



16. Remove the Two-piece Piston Assembly as follows:



**CAUTION** – Be careful not to damage the seating surface of the Piston Stem when performing the next step. Even the slightest nick or distortion of the seating surface may cause a high pressure leak when reassembled requiring disassembly of the first stage and replacement of the Piston Stem.

- a. Carefully insert a 5/32" hex key into the bore of the Piston Stem (**14**) to engage the hex feature inside the bore. When properly engaged you should be able to rotate the Piston Flange (**3**) by rotating the hex key.

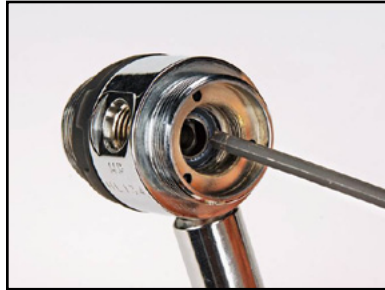

- b. Insert the First Stage Seat Retainer Tool into the slots in the Piston Flange to stabilize it while rotating the hex key counterclockwise to separate the Piston Flange from the Piston Stem. This will allow the Spring (**5**) and the Three-Pin Link (**6**) to be removed from the Body and set aside for cleaning and reassembly.



- c. Using tool 20-626-400 mount the piston flange to remove inner O-ring as shown. Set aside the piston flange for cleaning, inspection and reassembly.



d. Push on the threaded end of the Piston Stem through the bore to remove it from the Body. Remove the O-ring and two back-up rings and discard them. Set aside the Piston Stem and cleaning, inspection and reassembly.

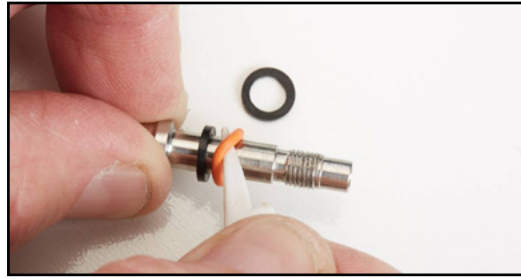
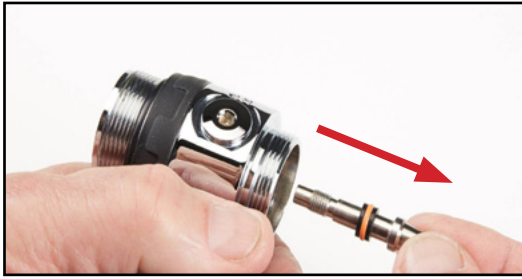

e. It is likely that the Piston Guide (40) will remain inside the body; this one should have to be removed also.

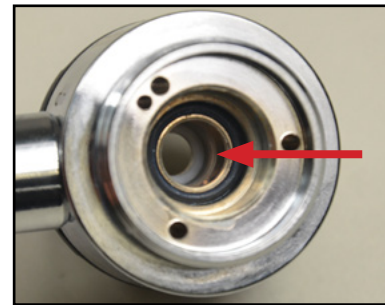

16. Remove Vent Ring (8) and O-ring (7) from the Body. Set aside for cleaning and reassembly.



17. Using a soft brass pick or equivalent remove and discard O-ring (15) from the Body at the location where the Seat Retainer was removed. Set aside Body for cleaning and reassembly.

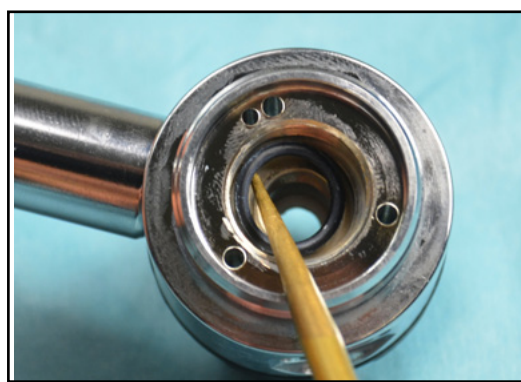
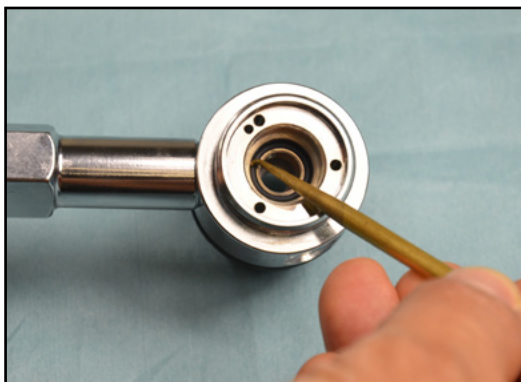

**SECTION 2****GENERAL CLEANING PROCEDURE**

18. Thermoplastic, silicone rubber and anodized aluminum parts, such as diaphragms, adjustment knobs, and thermoplastic housings.
- Soak in a solution of warm water and ordinary liquid dish detergent. Scrub with a soft nylon bristle brush to remove deposits.
  - Rinse with fresh water and blow dry with clean low pressure compressed air.
19. Chrome-plated Brass and Stainless Steel parts –
- When only mild deposits are visible, soak in a solution of warm water and ordinary liquid dish detergent. Scrub with a soft nylon bristle brush to remove deposits.
  - If warm water soaking & scrubbing does not remove deposits, use a commercial grade heated ultrasonic cleaner, Sherwood Scuba recommends Lawrence-Factor's LFW (Lawrence Factor Wash UN# 1805) solution diluted with water 50/50 and a 3-10 min treatment. Monitor immersed parts for signs of chrome peeling off. Do not subject thermoplastic or rubber parts to ultrasonic cleaning.
  - Alternatively, if an ultrasonic cleaner is not available soak parts in mild solution of white vinegar and water (50%) for about 30-60 minutes.
  - Rinse first with freshwater and follow up with a final rinse in deionized (distilled) water. Tap water typically contains minerals that will leave undesirable residue on the cleaned parts if final rinse is omitted.
21. Hoses –
- Corrosion or mineral deposits on the metallic fittings on hoses may be cleaned using the procedure presented above provided that care is taken to just dip only the metal fittings at each the end of the hose into the cleaning solution. Take care to prevent entrance of the solution into the hose interior.
  - Rinsing should include flushing the interior of the hose with fresh water followed by drying with compressed air.

# SECTION 3

## INSPECTION AND LUBRICATION PROCEDURES

*General – Inspection and lubrication must be preceded by thorough cleaning to enable adequate exposure of damaged parts and proper application of lubricant.*

### Inspection

22. Inspect all O-rings that are intended for reinstallation for signs of damage such as tears, cuts, brittleness or abrasion. If damaged replace. Do not reinstall.
23. Inspect the first stage Dry Chamber vent hole in the Body. Direct light into the Dry Chamber of the Body and you should be able to see that the vent hole is clear. If it is not, pass a small pin or wire with a diameter slightly less than the hole size through the hole to remove any obstructions. Do not reassemble if you are unable to confirm that the hole is clear.



24. Inspect the sealing edge of the Piston Stem using a magnifier. If there are any nicks, cuts or other deformities at the sealing edge the first stage may not provide the high pressure seal needed for the regulator to maintain a stable intermediate pressure. If such damage exists the Piston Stem must be replaced.

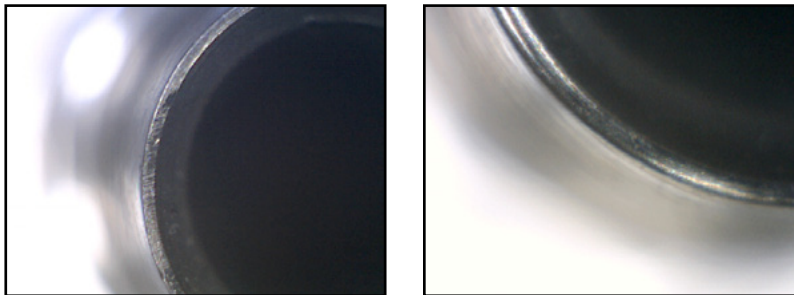

25. Inspect O-ring groove on the largest diameter of the Piston Flange **(3)** and the interior walls of the first stage End Cap **(26)** for scratches, gouges or deposits that could interfere with sealing. Parts with defects that cannot be remedied with cleaning must be replaced.
26. Inspect the sealing surface in the Body that will receive O-ring **(15)**. It must be free of gouges, scratches and debris.

27. Inspect the Dry Chamber Diaphragm (**19**) for signs of damage such as cuts or tears. If damaged replace it.
28. Inspect the Yoke (**31**) and Yoke Retainer (**34**) for cracks or distortion. If damaged replace it. Parts with chipped or scratched plating are still functional and need only to be replaced at the discretion of the owner.
29. Inspect Body (**9**), Yoke Retainer (**34**) or Din Filter Housing (**40**), Port Swivel (**24**), Swivel Retainer (**28**) and first stage diaphragm Retainer Cap (**20**) for damage to threads. If threads are damaged the affected parts should be replaced. Parts with chipped or scratched plating need only to be replaced at the discretion of the owner.

## **Lubrication**

*Tribolube 71 is the recommended lubricant for Sherwood regulators. Alternatively Christolube 111 could be considered as a viable substitute. Silicone lubricant is NOT approved and may present a hazard for use with Enriched Air Nitrox (EAN).*



### 30. O-ring lubrication

- a. General – O-rings in most instances should receive only enough lubricant to ensure they are supple. A light coating of lubricant should present a surface that glistens but without a defined layer of lubricant visible.
- b. Ample – When an ample application of lubricant is specified it generally applies to a dynamic O-ring subject to considerable motion or environmental conditions where a more generous application of lubricant might be beneficial. In this situation there should be a light film or layer of lubricant visible.

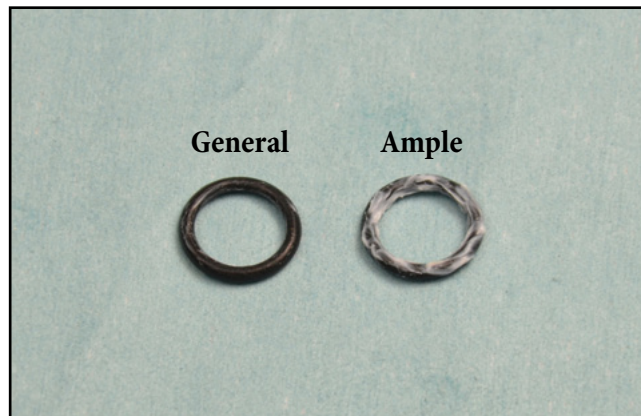



## SECTION 4 REASSEMBLY PROCEDURES

31. Install the Vent Ring onto the Valve Body.



32. Inspect the Body cavity for accepting the HP Seat to be certain there are no contaminants present, Apply ample lubricant to O-ring (15) and install it into the Body.

33. Reassemble the Piston Assembly as follows:

a. Install O-ring (2) onto the Piston Flange (3).

b. Place the Piston Flange over the O-ring installation Tool (PN# 20-626-400) and install O-ring (4). Remove installation tool and set aside the Piston Flange for later assembly.



c. Use 20-685-400 Piston Stem O-ring Tool to cover the piston stem threaded end. Slide both the backup rings and the O-ring over the tool to install. The tool will protect the inner sealing surface of the O-ring from being sliced by the piston stem threads. Ensure the correct order of piston guide, backup rings and O-ring. The two back-up rings must have their cupped surfaces against the red O-ring. Picture also shows white piston guide (40) used in SR2 only.



- d. Place the sealing end of the Piston Stem over a 5/32" hex key and use this tool to guide the threaded end of the Piston Stem through the Body until the threaded end is in position at the opposite side of the Body to install the Piston Flange. **Extreme caution is encouraged while inserting tool to prevent damage to Piston Stem's sharp edge.**



- e. Install the Three-Pin Link ensuring that the pins align with the holes in the Body until the Three-Pin Link fully seats inside the Body.



- f. Insert Spring in Body.

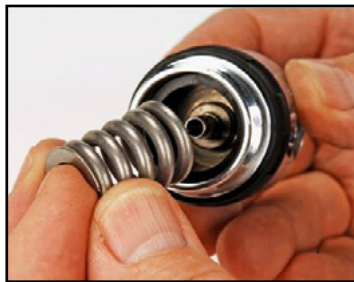

- g. Generally lubricate both the Piston Flange exterior O-ring and the sealing surface of the body. While the Piston Stem is secured by the 5/32" hex key go to the other end & start threading the the Piston Flange threaded end clockwise by hand until bottoms, then using the 20-750-150 First Stage Seat Retainer Tool into the slots at the Piston Flange thighten slightly to stabilize it until just snug. Only light torque is sufficient to avoid thread damage.



34. Install amply lubricated O-ring (7) taking care to avoid damage to the O-ring as it passes over the threads on the Body.



**CAUTION** – It is *imperative* that O-ring (7) is amply lubricated to minimize deformation when the HP seat retainer gets fully torqued.





**CAUTION** – It is absolutely essential for the surface of the seat to be clean and free of any scratches, distortion or any contaminants to ensure it will seal against the incoming high pressure, failure to observe this precaution may result in leakage and possible damage to the regulator.

35. Install a new Seat in the Seat Retainer and install it by hand first into the body. Secure the Body with 1st stage handle and padded vise. Using the Seat Retainer Tool and a Torque Wrench torque Seat Retainer to 7 ft·lb.



36. Install the Pressure Plate into the Body. Install the Dry Chamber Diaphragm into the Retainer Cap and then install the Retainer Cap onto the Body. Tighten until snug. Alignment of the Sherwood logo is random.

37. Reassemble Port Swivel and End Cap as follows:

- a. Install O-rings (**7** & **25**) onto the Port Swivel. Install anti friction Washer (**27**) into End Cap.
- b. Install End Cap onto the Port Swivel. Install Swivel Retainer into the Port Swivel and thread it with 1/4" hex key. Stabilize the Port Swivel using tool 20-115-100 and padded vise. Use torque wrench and torque to 60 in·lb (5 ft·lb).

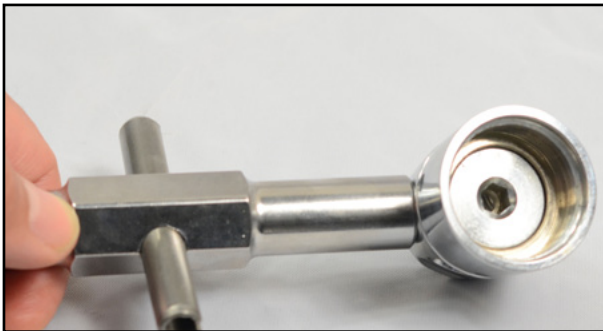

- c. Install Accent Ring (**23**).

**If the first stage has a yoke type connector go to steps 9 through 12. If the first stage is a DIN type, go to step 13.**

38. Install a new Filter in the Yoke Retainer and secure with the Retaining Ring **(32)** . Compress the Retaining Ring with Retaining Ring Pliers and insert it into the bore of the Yoke Retainer until it seats in the groove.
39. Install O-ring **(35)** on to the Yoke Retainer.
40. Place the Yoke Saddle, Inlet Protector and Yoke in alignment over the Body and insert the Yoke Retainer through the group of parts threading it into the Body until snug. Be certain to observe the orientation of the Inlet Protector so that when the regulator is fully assembled the open end of the Inlet Protector will cover the inlet of the Yoke Retainer.
41. Secure the Body in a bench vise taking care to avoid damage to the Body exterior.
42. Engage the hex feature of the Yoke Retainer with the 1" Yoke Retainer Socket (P/N 20-155-500). Insert a 3/8" Drive Extension (P/N 20-156-500) through the Yoke and use a torque wrench to tighten the Yoke Retainer to approximately 25 ft-lbs. Remove the tools and install the Yoke Screw.
43. DIN Connector Reassembly.
  - a. Replace O-ring **(35)** over the external threads of the DIN Filter Housing.
  - b. Place the Yoke Saddle over the Body and insert the DIN Filter Housing into the Body. Torque to approximately 24 ft-lbs. This will require a 9/16" Crow's Foot attachment and a torque wrench to measure torque.
  - c. Place the loop of the DIN Inlet Protector **(42)** over the DIN Filter Housing taking care to orient the inlet cap portion of the protector so that it will cover the inlet when the regulator is fully assembled.
  - d. Install the DIN Handwheel.
  - e. Insert a new Filter and secure by inserting the Din Filter Retainer. Use a 1/4" hex wrench and tighten to approximately 40 in-lbs.
  - f. Insert a new O-ring **(38)** into the DIN Filter Retainer.
44. Install End Cap and Port Swivel Assembly onto the Body. Hand tighten until gap between End Cap and Body is closed. Use First Stage Spanner (P/N 20-600-200) if necessary.
45. Replace O-rings **(22)** on all LP Port Plugs and O-rings **(10)** on HP Port Plugs.
46. Refer to notes taken before disassembly of first stage to install accessories with hoses into LP and HP ports. Install LP Port Plugs and HP Port Plugs into remaining open ports.

# SECTION 5

## FIRST STAGE TEST PROCEDURE

47. Connect a calibrated intermediate pressure gauge to the regulator. Use of a BCD hose and a mating quick - disconnect fitting for the gauge provides a simple means for connection.



**CAUTION** – To provide a means of pressure relief for the system in the event intermediate pressure exceeds 200 psi, ensure that a properly adjusted second stage regulator is connected to the first stage before exposing the first stage to pressure. Failure to take this measure could expose the attached hoses and the gauge to excessive pressure and may result in injury to bystanders or damage to the regulator.

48. Initially connect the first stage to a supply limited to 300 psi and slowly open the valve to apply the pressure to the first stage. Observe the intermediate pressure and close the valve immediately if it exceeds 160 psi. The intermediate pressure should be 135 +/- 10 psi. If the intermediate pressure is above 145 psi, manually depress the Dry Chamber Diaphragm and then purge the second stage. Repeat this cycle 15 to 20 times. If the intermediate pressure does not stabilize within the specified range either the Seat or the sealing tip of the Piston Stem is damaged or contaminated.



**NOTE** – The SR1 & SR2 has been designed not to require adjustments to the Intermediate Pressure. In the event that the intermediate pressure becomes low the use of up to 3 shims is allowed; if the IP is still low the Spring (**5**) would have to be replaced. If the IP is high or erratic (creeping) consult the reassembly procedure to be certain that it has been followed correctly. If procedures have been properly followed, the HP seat and edge of the piston stem are clean of debris and deformations and the intermediate pressure is still out of range, contact your Sherwood Distributor for technical advice.

49. If the intermediate pressure is within the specified range and no leakage is detected, repeat the above step using an inlet pressure of 2500 +/- 500 psi.

### Dry Chamber Functional Test

50. With the Intermediate Pressure Gauge still connected to the first stage, manually depress the Dry Chamber Diaphragm if working on **SR1 first stages** and remove cap and diaphragm and apply direct pressure to pressure plate (**18**) on **SR2 1st stages**. When functioning properly you should see an increase in intermediate pressure of 3 to 10 psi. Purge the second stage and repeat to confirm. If there is no rise in intermediate pressure the likely cause is improper assembly. Check procedures to confirm all parts are installed as specified.

### External Leak Test

51. After the first stage and mating second stage has been assembled and adjusted, connect the complete regulator to a pressure source at 2500 +/- 500 psi. Submerge the entire assembly in clean water and inspect for any continuous stream of air bubbles. Maintain observation for one minute and if leakage is present, note the location of the source of bubbles and refer to Trouble Shooting Guide.

**This completes the overhaul service procedure for the SR1 & SR2 First Stage Regulators.**



# SCHEMATICS

## SR2 FIRST STAGE

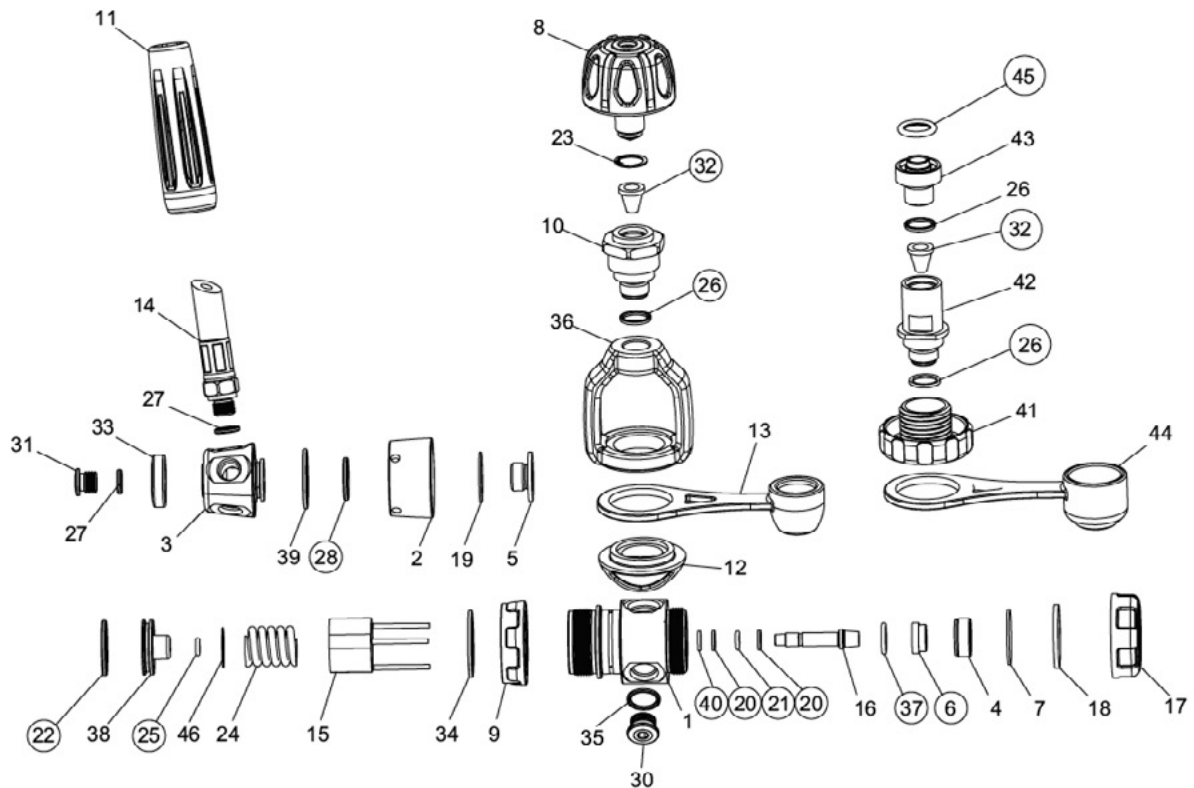

ITEM	PART #	DESCRIPTION
1	2015-9	Body
2	1105-26	End Cap
3	1105-24	Port Swivel
4	1105-17	HP Seat Retainer
5	1105-50	Swivel Retainer
6	1105-16	HP Seat
7	1105-18	Pressure Plate
8	1105-30	Yoke Knob
9	1105-8	Vent Ring
10	1105-34	Yoke Retainer
11	1105-29	Hose Protector Long
12	1105-37	Saddle
13	1105-36	Inlet Protector
14	SHV7530	LP Hose Assy
15	1105-6	Three Pin Link

ITEM	PART #	DESCRIPTION
16	1105-14	Piston Stem
17	2105-20	Retainer Cap
18	2105-19	Dry Chamber Diaph
19	1105-27	Washer, Teflon
20	110009	Back up Ring
21	980009R	O-ring, red
22	980020	O-ring
23	1105-32	Retaining Ring
24	1105-5	Spring
25	970008	O-ring
26	980905	O-ring
27	970903	O-ring
28	970016	O-ring
30	SHV7074	HP Port Plug
31	SHV7039	LP Port Plug
32	1105-33	Filter

ITEM	PART #	DESCRIPTION
33	1105-23	Accent Ring
34	970023	O-ring
35	970904	O-ring
36	1105-31	Yoke
37	980013	O-ring
38	1105-3	Piston Flange
39	970021	O-ring
40	100335	Piston Guide
41	1105-41	Hand Wheel, DIN
42	1105-40	Filter Housing, DIN
43	1105-39	Filter Retainer, DIN
44	1105-42	Inlet Protector, DIN
45	980111	O-ring
46	1105-55	Shim

\*Circled parts included in service kit